

बिड दस्तावेज़ / Bid Document

| बिड विवरण/Bid Details | |
|--|--|
| बिड बंद होने की तारीख/समय /Bid End Date/Time | 25-06-2026 20:00:00 |
| बिड खुलने की तारीख/समय /Bid Opening Date/Time | 25-06-2026 20:30:00 |
| बिड पेशकश वैधता (बंद होने की तारीख से)/Bid Offer Validity (From End Date) | 180 (Days) |
| मंत्रालय/राज्य का नाम/Ministry/State Name | Ministry Of Heavy Industries And Public Enterprises |
| विभाग का नाम/Department Name | Department Of Heavy Industry |
| संगठन का नाम/Organisation Name | National Automotive Board |
| कार्यालय का नाम/Office Name | National Automotive Board Manesar |
| शिकायत निवारण के संपर्क विवरण/ Contact details of Grievance redressal | buyer5.dhi.hr@gembuyer.in |
| वस्तु श्रेणी /Item Category | Repair, Maintenance, and Installation of Plant/ Systems/Equipments (Version 2) - Automotive Test Agency; Upgradation of Controller and Software of Test Machines (Emergency Locking Retractor, Retractor Durability, Microslip/Abrasion and Bus Window Dur.. |
| अनुबंध अवधि /Contract Period | 3 Month(s) 23 Day(s) |
| एमएसएमई के लिए अनुभव के वर्षों और टर्नओवर से छूट प्रदान की गई है/MSE Relaxation for Years of Experience and Turnover | No |
| स्टार्टअप के लिए अनुभव के वर्षों और टर्नओवर से छूट प्रदान की गई है /Startup Relaxation for Years of Experience and Turnover | No |
| विक्रेता से मांगे गए दस्तावेज़/Document required from seller | Experience Criteria,Bidder Turnover,Certificate (Requested in ATC),OEM Authorization Certificate,Additional Doc 1 (Requested in ATC),Additional Doc 2 (Requested in ATC),Additional Doc 3 (Requested in ATC),Additional Doc 4 (Requested in ATC) *In case any bidder is seeking exemption from Experience / Turnover Criteria, the supporting documents to prove his eligibility for exemption must be uploaded for evaluation by the buyer |
| क्या आप निविदाकारों द्वारा अपलोड किए गए दस्तावेज़ों को निविदा में भाग लेने वाले सभी निविदाकारों को दिखाना चाहते हैं? संदर्भ मेनू है/Do you want to show documents uploaded by bidders to all bidders participated in bid? | Yes (Documents submitted as part of a clarification or representation during the tender/bid process will also be displayed to other participated bidders after log in) |

| बिड विवरण/Bid Details | |
|--|-----------------------------------|
| बिड लगाने की समय सीमा स्वतः नहीं बढ़ाने के लिए आवश्यक बिड की संख्या। / Minimum number of bids required to disable automatic bid extension | 3 |
| दिनों की संख्या, जिनके लिए बिड लगाने की समय-सीमा बढ़ाई जाएगी। / Number of days for which Bid would be auto-extended | 7 |
| ऑटो एक्सटेंशन अधिकतम कितनी बार किया जाना है। / Number of Auto Extension count | 2 |
| बिड से रिवर्स नीलामी सक्रिय किया/Bid to RA enabled | Yes |
| रिवर्स नीलामी योग्यता नियम/RA Qualification Rule | H1-Highest Priced Bid Elimination |
| बिड का प्रकार/Type of Bid | Two Packet Bid |
| तकनीकी मूल्यांकन के दौरान तकनीकी स्पष्टीकरण हेतु अनुमत समय /Time allowed for Technical Clarifications during technical evaluation | 2 Days |
| मूल्यांकन पद्धति/Evaluation Method | Total value wise evaluation |
| मूल्य दर्शाने वाला वित्तीय दस्तावेज ब्रेकअप आवश्यक है / Financial Document Indicating Price Breakup Required | Yes |
| मध्यस्थता खंड/Arbitration Clause | No |
| सुलह खंड/Mediation Clause | No |

ईएमडी विवरण/EMD Detail

| | |
|-----------------------------|-----------|
| एडवाइजरी बैंक/Advisory Bank | HDFC Bank |
| ईएमडी राशि/EMD Amount | 79680 |

ईपीबीजी विवरण /ePBG Detail

| | |
|---|-----------|
| एडवाइजरी बैंक/Advisory Bank | HDFC Bank |
| ईपीबीजी प्रतिशत (%) /ePBG Percentage(%) | 5.00 |
| ईपीबीजी की आवश्यक अवधि (माह) /Duration of ePBG required (Months). | 30 |

(a). जेम की शर्तों के अनुसार ईएमडी छूट के इच्छुक बिडर को संबंधित कटेगरी के लिए बिड के साथ वैध समर्थित दस्तावेज प्रस्तुत करने है। एमएसई कटेगरी के अंतर्गत केवल वस्तुओं के लिए विनिर्माता तथा सेवाओं के लिए सेवा प्रदाता ईएमडी से छूट के पात्र हैं। व्यापारियों को इस नीति के दायरे से बाहर रखा गया है।/EMD EXEMPTION: The bidder seeking EMD exemption, must submit the valid supporting document for the relevant category as per GeM GTC with the bid. Under MSE category, only manufacturers for goods and Service Providers for Services are eligible for exemption from EMD. Traders are excluded from the purview of this

Policy.

(b). ईएमडी और संपादन जमानत राशि, जहां यह लागू होती है, लाभार्थी के पक्ष में होनी चाहिए। / EMD & Performance security should be in favour of Beneficiary, wherever it is applicable.

(c). ईएमडी और संपादन जमानत राशि लाभार्थी के पक्ष में होनी चाहिए। / Earnest Money Deposit (EMD) shall also be accepted by the buyer in the form of a surety bond.

लाभार्थी /Beneficiary :

International Centre for Automotive Technology
Plot No. 26, Sector-3, HSIIDC, IMT Manesar, Gurugram-122051
(Icat)

बोली विभाजन लागू नहीं किया गया/ Bid splitting not applied.

एमआईआई अनुपालन/MII Compliance

| | |
|-------------------------------|-----|
| एमआईआई अनुपालन/MII Compliance | Yes |
|-------------------------------|-----|

एमएसई खरीद वरीयता/MSE Purchase Preference

| | |
|---|-----|
| एमएसई खरीद वरीयता/MSE Purchase Preference | Yes |
| सूक्ष्म और लघु उद्यम मूल उपकरण निर्माताओं/सेवा प्रदाता को खरीद में प्राथमिकता, यदि उनका मूल्य $L1+X\%$ / Purchase Preference to MSE OEMs/ Service Provider available upto price within $L1+X\%$ | 15 |

- 1. Purchase preference to Micro and Small Enterprises (MSEs):** Purchase preference will be given to MSEs having valid Udyam Certificate and whose credentials are validated online through Udyam Registration portal as defined in Public Procurement Policy for Micro and Small Enterprises (MSEs) Order, 2012 dated 23.03.2012 issued by Ministry of Micro, Small and Medium Enterprises and its subsequent Orders/Notifications issued by concerned Ministry. If the bidder wants to avail themselves of the Purchase preference, the bidder must be the manufacturer / OEM of the offered product on GeM. In respect of bid for Services, the bidder must be the Service provider of the offered Service. Traders are excluded from the purview of Public Procurement Policy for Micro and Small Enterprises and hence resellers offering products manufactured by some other OEM are not eligible for any purchase preference. Relevant documentary evidence in this regard shall be uploaded along with the bid in respect of the offered product or service, and Buyer will decide eligibility for purchase preference based on documentary evidence submitted in case of product bids, whereas in case of services the eligibility is automatically validated. If L-1 is not an MSE and MSE Seller (s) has / have quoted price within L-1+ 15% (Selected by Buyer) of margin of purchase preference /price band defined in relevant policy, such MSE Seller shall be given opportunity to match L-1 price and contract will be awarded for % (selected by Buyer) percentage of total quantity. The buyers are advised to refer the [OM No.1 4 2021 PPD dated 18.05.2023](#) for compliance of Concurrent application of Public Procurement Policy for Micro and Small Enterprises Order, 2012 and Public Procurement (Preference to Make in India) Order, 2017. Benefits of MSE will be allowed only if seller is validated on-line in GeM profile as well as validated and approved by Buyer after evaluation of documents submitted.
- 2.** If L-1 is not an MSE and MSE Service Provider (s) has/have quoted price within L-1+ 15% of margin of purchase preference /price band as defined in the relevant policy, then 100% order quantity will be awarded to such MSE bidder subject to acceptance of L1 bid price.
- 3.** Estimated Bid Value indicated above is being declared solely for the purpose of guidance on EMD amount and for determining the Eligibility Criteria related to Turn Over, Past Performance and Project / Past Experience etc. This has no relevance or bearing on the price to be quoted by the bidders and is also not going to have any impact on bid participation. Also this is not going to be used as a criteria in determining reasonableness of quoted prices which would be determined by the buyer based on its own assessment of reasonableness and based on competitive prices received in Bid / RA process.
- 4.** Reverse Auction would be conducted amongst all the technically qualified bidders except the Highest quoting

bidder. The technically qualified Highest Quoting bidder will not be allowed to participate in RA. However, H-1 will also be allowed to participate in RA in following cases:

- If number of technically qualified bidders are only 2 or 3.
- If Buyer has chosen to split the bid amongst N sellers, and H1 bid is coming within N.
- In case Primary product of only one OEM is left in contention for participation in RA on elimination of H-1.
- If L-1 is non-MSE and H-1 is eligible MSE and H-1 price is coming within price band of 15% of Non-MSE L-1
- If L-1 is non-MII and H-1 is eligible MII and H-1 price is coming within price band of 20% of Non-MII L-1

एक्सेल में अपलोड किए जाने की आवश्यकता /Excel Upload Required :

Price Bid - [1781089157.xlsx](#)

अतिरिक्त योग्यता /आवश्यक डेटा/Additional Qualification/Data Required

Buyer to mention scope of work:[1781089834.pdf](#)

Terms and Conditions/ Deductions etc to be mentioned by Buyer as per their requirement:[1781089838.pdf](#)

This Bid is based on Least Cost Method Based Evaluation (LCS). The technical qualification parameters are:-

| Parameter Name | Max Marks | Min Marks | Evaluation Document | Seller Document Required |
|---------------------------------|-----------|-----------|---------------------------|--------------------------|
| Technical Evaluation Parameters | 100 | 80 | View file | Yes |

Total Minimum Passing Technical Marks: 80

Pre Bid Detail(s)

| मूल्य भिन्नता खंड दस्तावेज़/Pre-Bid Date and Time | प्री-बिड स्थान/Pre-Bid Venue |
|---|---|
| 12-06-2026 11:00:00 | Physical or Virtual Mode International Centre for Automotive Technology, Plot No. 26, Sector-3, HSIIDC, IMT Manesar, Gurugram-122051 Meeting link for virtual mode : https://teams.microsoft.com/meet/41958949468920?p=r1ApL3C1CxQOMDmprP |

Repair, Maintenance, And Installation Of Plant/ Systems/Equipments (Version 2) - Automotive Test Agency; Upgradation Of Controller And Software Of Test Machines (Emergency Locking Retractor, Retractor Durability, Microslip/Abrasion And Bus Window Dur.. (1)

तकनीकी विशिष्टियाँ /Technical Specifications

| विवरण/ Specification | मूल्य/ Values |
|----------------------|------------------------|
| कोर / Core | |
| Type of Premise | Automotive Test Agency |

| विवरण/ Specification | मूल्य/ Values |
|---|--|
| Type of Item/Product/System to be repaired or Installed | Upgradation of Controller and Software of Test Machines (Emergency Locking Retractor, Retractor Durability, Microslip/Abrasion and Bus Window Durability Test Rigs |
| Consumables to be provided by | Service Provider |
| Spare parts to be provided by | Service Provider |
| एडऑन /Addon(s) | |
| अतिरिक्त विवरण /Additional Details | |
| Estimated number of visits as per last year records | 0 |

क्रेता द्वारा निर्धारित न्यूनतम मूल्य/Minimum Floor Price defined by Buyer

| | |
|--|----|
| क्रेता द्वारा निर्धारित न्यूनतम मूल्य/Minimum Floor Price defined by Buyer | No |
|--|----|

अतिरिक्त विशिष्टि दस्तावेज /Additional Specification Documents

परेषिती/रिपोर्टिंग अधिकारी /Consignees/Reporting Officer and Quantity

| क्र.सं./S.N o. | परेषिती/रिपोर्टिंग अधिकारी /Consignee Reporting/Officer | पता/Address | Quantity | अतिरिक्त आवश्यकता /Additional Requirement |
|----------------|---|---|-------------------------|---|
| 1 | Girish Chander | 122051,INTERNATIONAL CENTRE FOR AUTOMOTIVE TECHNOLOGY Plot No 26, Sector 3, HSIIDC, IMT-Manesar, Gurgaon 122050 | Project / Lumpsum Based | <ul style="list-style-type: none"> Estimated Cost of Spare/Consumables/Items on Reimbursement basis in Rs (please input 0 if not applicable) : 0 |

क्रेता द्वारा जोड़ी गई बिड की विशेष शर्तें/Buyer Added Bid Specific Terms and Conditions

1. Generic

OPTION CLAUSE 25% : The buyer can increase or decrease the contract quantity or contract duration up to 25 percent at the time of issue of the contract. However, once the contract is issued, the contract quantity or contract duration can only be increased up to 25 percent. Bidders are bound to accept the revised quantity or duration.

For lumpsum-based service contracts, the buyer may increase the scope of work and contract value up to 25 percent with the consent of the service provider

2. Buyer Added Bid Specific ATC

Buyer uploaded ATC document [Click here to view the file.](#)

अस्वीकरण/Disclaimer

The Additional Terms and Conditions (ATC) have been incorporated by the Buyer after approval of their Competent Authority. The Buyer, is solely responsible for the impact of these clauses on the bidding process, its outcome, and consequences thereof including any restriction arising in the bidding process due to these ATCs and including the modification of technical specifications and / or terms and conditions governing the bid. All representations / grievances pertaining to the ATC clauses shall be raised with the buyer organization directly and not with GeM. If any of the clause(s) is/are incorporated by the Buyer regarding the following, the bid & resultant contract shall be treated as null & void. Further, GeM reserves the right, at its sole discretion, to cancel the bid forthwith, without issuance of any prior notice or intimation :-

1. Publishing Custom / BOQ bids for items for which regular GeM categories are available (unless such Custom / BOQ item is bunched with the major regular product Category Item).
2. Mandating procurement of / from specific Brand / Make / Model / Manufacturer / Dealer except in case of Single Bid / Proprietary Article Certificate (PAC) Buying.
3. Inclusion of disqualification criteria related to suspension of seller / service provider, where such suspension period has already expired.
4. Mandating submission of documents in physical form as a pre-requisite to qualify bidders.
5. Publishing bids on GeM for procurement of works.
6. Procurement of Goods by creating a Service bid on GeM & vice-versa.
7. Seeking sample with bid or approval of samples during bid evaluation process. However, trial / sample, as the case may be, shall be permitted in cases where trial / sample are allowed as per approved and published procurement policy of the Buyers' controlling Ministry / Department / State / Public Sector Enterprises Headquarters. If there is any violation of trial / sample clause with regard to approved policy of the Buyers' Ministry / Department / State / Public Sector Enterprises Headquarters, then this is to be determined and redressed by the concerned Buyer Organisation only.
8. Seeking experience from specific organization / department / institute only or from foreign / export experience.
9. Creating bid for items from incorrect categories.
10. Reference of conditions published on any external site or reference to external documents/clauses.
11. Asking for any Tender fee / Bid Participation fee, as the case may be.
12. Buyer added ATC Clauses which are in contravention of clauses defined in bid detail section, including specifications, EMD Detail, ePBG Detail and MII and MSE Purchase Preference sections of the bid, unless otherwise allowed by the applicable GeM GTC.
13. Any ATC clause in contravention with GeM GTC Clause 4 (xiii) (h) will be invalid. In case of multiple L1 bidders against a service bid, the buyer shall place the Contract by selection of a bidder amongst the L-1 bidders through a Random Algorithm executed by GeM system.
14. In a category based bid, adding additional items, through buyer added, additional scope of work/ additional terms and conditions/or any other document. If buyer needs more items along with the main item, the same must be added through bunching category based items or by bunching custom catalogues or bunching a BoQ with the main category based item, the same must not be done through ATC or Scope of Work.

Further, if any seller has any objection/grievance against these additional clauses or otherwise on any aspect of this bid, they can raise their representation against the same by using the Representation window provided in the bid details field in Seller dashboard after logging in as a seller. Buyer is duty bound to reply to all such representations and would not be allowed to open bids if he fails to reply to such representations.

All GeM Sellers/Service Providers shall ensure full compliance with all applicable labour laws, including the provisions, rules, schemes and guidelines under the four Labour Codes i.e. the Code on Wages, 2019; the Industrial Relations Code, 2020; the Occupational Safety, Health and Working Conditions Code, 2020; and the Code on Social Security, 2020 as and when notified and brought into force by the Government of India.

For all provisions of the Labour Codes that are pending operationalisation through rules, schemes or notifications, the corresponding provisions of the pre-existing labour enactments (such as The Minimum Wages Act, 1948, The Payment of Wages Act, 1936, The Payment of Bonus Act, 1965, The Equal Remuneration Act, 1976, The Payment of Gratuity Act, 1972, etc. and relevant State Rules) shall continue to remain applicable.

The Seller/ Service Providers shall, therefore, be responsible for ensuring compliance under:

- **All notified and enforceable provisions of the new Labour Codes as mentioned hereinabove; and**
- **All operative provisions of the erstwhile Labour Laws until their complete substitution.**

All obligations relating to wages, social security, safety, working conditions, industrial relations etc. and any other statutory requirements shall be strictly met by the Seller/ Service Provider. Any non-compliance shall constitute a breach of the contract and shall entitle the Buyer to take appropriate action in accordance with the contract and applicable law.

This Bid is governed by the General Terms and Conditions, conditions stipulated in Bid and Service Level Agreement specific to the Service, as the case may be, as provided in the Marketplace.

However, in case of Service, if any condition specified in General Terms and Conditions is contradicted by the conditions stipulated in Service Level Agreement specific to said Service, then it will over-ride the conditions in the General Terms and Conditions.

This Bid is governed by the [सामान्य नियम और शर्तें/General Terms and Conditions](#), conditions stipulated in Bid and [Service Level Agreement](#) specific to this Service as provided in the Marketplace. However in case if any condition specified in सामान्य नियम और शर्तें/General Terms and Conditions is contradicted by the conditions stipulated in Service Level Agreement, then it will over ride the conditions in the General Terms and Conditions.

जेम की सामान्य शर्तों के खंड 26 के संदर्भ में भारत के साथ भूमि सीमा साझा करने वाले देश के बिडर से खरीद पर प्रतिबंध के संबंध में भारत के साथ भूमि सीमा साझा करने वाले देश का कोई भी बिडर इस निविदा में बिड देने के लिए तभी पात्र होगा जब वह बिड देने वाला सक्षम प्राधिकारी के पास पंजीकृत हो। बिड में भाग लेते समय बिडर को इसका अनुपालन करना होगा और कोई भी गलत घोषणा किए जाने व इसका अनुपालन न करने पर अनुबंध को तत्काल समाप्त करने और कानून के अनुसार आगे की कानूनी कार्रवाई का आधार होगा।/In terms of GeM GTC clause 26 regarding Restrictions on procurement from a bidder of a country which shares a land border with India, any bidder from a country which shares a land border with India will be eligible to bid in this tender only if the bidder is registered with the Competent Authority. While participating in bid, Bidder has to undertake compliance of this and any false declaration and non-compliance of this would be a ground for immediate termination of the contract and further legal action in accordance with the laws.

---धन्यवाद/Thank You---

International Centre for Automotive Technology

**Additional Terms & Conditions (ATC) for
Upgradation of Controller and Software of Test Machines
(Emergency Locking Retractor, Retractor Durability,
Microslip/Abrasion and Bus Window Durability Test Rigs.)
in Component Test Lab (CTL) at ICAT Centre- I,
Manesar, Haryana**

Tender No. ICAT/GeM/CTL/Upgradation-C&S/2026-27/86



International Centre for Automotive Technology

Plot No. - 26, Sector-3, HSIIDC, IMT Manesar, Gurgaon-122050, Haryana, India
Phone: +91-124-4586-111, FAX: +91-124-2290005, Email: purchase@icat.in, Website www.icat.in

TABLE OF CONTENTS

| SNo | Particulars | Page No |
|-----|---|---------|
| 1. | निविदा सूचना / Tender Notice | 4-5 |
| 2. | Chapter 1: ICAT और साइट के बारे में जानकारी / About ICAT & Site Description | 6 |
| 3. | Chapter 2: काम का दायरा, विस्तृत तकनीकी विनिर्देश और स्वीकृति मानदंड / Scope of Work, Detailed Technical Specification, and Acceptance Criteria | 7-24 |
| 4. | Chapter 3: न्यूनतम पात्रता मानदंड / Minimum Eligibility Criteria | 25-27 |
| 5. | Chapter 4: बोली अस्वीकार करने के मानदंड / Bid Rejection Criteria | 28 |
| 6. | Chapter 5: बोली के मूल्यांकन के मानदंड / Bid Evaluation Criteria | 29-30 |
| 7. | Chapter 6: घोषणा चेकलिस्ट / Declaration Checklist | 31-32 |
| 8. | Chapter 7: बोली लगाने वालों के लिए निर्देश / Instructions To Bidders | 33-35 |
| 9. | Chapter 8: बयाना राशि (EMD) / Earnest Money Deposit (EMD) | 36-37 |
| 10. | Chapter 9: अनुबंध की विशेष शर्तें / Special Conditions of Contract | 38 |
| 11. | Chapter 10: पूर्व-स्वीकृति मानदंड / Pre-Acceptance Criteria | 39 |
| 12. | Chapter 11: अंतिम स्वीकृति मानदंड / Final Acceptance Criteria | 40 |
| 13. | Form I: वेंडर जानकारी फॉर्म (VIF) / Vendor information form (VIF) | 41 |
| 14. | Form II: न्यूनतम पात्रता मानदंडों के लिए चेकलिस्ट / Checklist for minimum eligibility criteria | 42 |
| 15. | Form III: बोली लगाने वाले की ओर से स्वीकृति / Acceptance from the bidder | 43 |
| 16. | Form IV: घोषणा-पत्र का प्रारूप / Format for declaration | 44-45 |
| 17. | Form V: अर्नेस्ट मनी डिपॉजिट (EMD) का फॉर्मेट / Format of Earnest Money | 46-48 |
| 18. | Form VI: EMD/बिड सिक्योरिटी के बदले घोषणा का प्रारूप / Format of declaration in lieu of EMD/Bid security | 49-50 |
| 19. | Form VII: परफॉर्मेंस बैंक गारंटी के लिए प्रोफॉर्मा / Proforma for Performance Bank Guarantee | 51-52 |
| 20. | Form VIII: उपक्रम / Undertaking | 53 |
| 21. | Form IX: प्रमुख अनुबंधों का विवरण / Details of major contracts | 54 |
| 22. | Form X: सुझाए गए बदलाव / Deviations Suggested | 55 |
| 23. | Form XI: हितों के टकराव के संबंध में घोषणा / Declaration in Respect of Conflict of Interest | 56-60 |
| 24. | Form XII: प्रोडक्ट सपोर्ट घोषणा / Product Support Declaration | 61 |

| | | |
|-----|---|-------|
| 25. | Form XIII : निर्माता का प्राधिकरण फॉर्म (MAF) / Manufacturer's Authorization Form (MAF) | 62 |
| 26. | Form XIV : बोली लगाने वाले की ओर से घोषणा और वचन-पत्र / Declaration and Undertaking from Bidder | 63 |
| 27. | Form XV : कोई विचलन न होने का घोषणा-पत्र / No Deviation Declaration | 64 |
| 28. | Form XVI : प्रोडक्ट अनुपालन के लिए वचन-पत्र / Undertaking for Product Compliance | 65 |
| 29. | Form XVII : उत्पाद के लिए वचन-पत्र / Undertaking for Non Subcontracting | 66 |
| 30 | Form XVIII : कीमत की उचितता का घोषणा पत्र / Price Reasonability Declaration Letter | 67 |
| 31. | Form XIX : चेकलिस्ट फॉर्म / Checklist Form | 68-78 |

निविदा सूचना / Tender Notice

Subject: Upgradation of Controller and Software of Test Machines (Emergency Locking Retractor, Retractor Durability, Microslip/Abrasion and Bus Window Durability Test Rigs.) in Component Test Lab (CTL) at ICAT Centre- I, Manesar, Haryana.

Sir/Madam,

The International Centre for Automotive Technology (ICAT) under Ministry of Heavy Industries, Government of India, invites tenders in two bid system from the Bidders in the prescribed proforma for performing, executing and implementing the Works on the terms and conditions contained in this Tender Document and in the Contract. The brief description of Works and the timelines for tenders are summarized in the table below.

| | | |
|----|-----------------------|---|
| 1. | Scope of supply | <p>Upgradation of Controller and Software of Test Machines (Emergency Locking Retractor, Retractor Durability, Microslip/Abrasion and Bus Window Durability Test Rigs.) in Component Test Lab (CTL) at ICAT Centre- I, Manesar, Haryana</p> |
| 2. | Earnest Money Deposit | <p>INR 79,680/- (Rupees Seventy-nine thousand six hundred eighty only) in form of DD/NEFT/Bank Guarantee (format as per Form V of this ATC)/Banker's Cheque in favor of "International Centre for Automotive Technology", payable at Manesar / Gurgaon valid for at least six months from any Indian scheduled Bank. The above Bank Guarantee to be issued/endorsed by any branch at Delhi/NCR of Indian Scheduled bank and should be consisting of Full Address of the bank along with contact details i.e. name, contact no., fax no. & e-mail id of the responsible person issuing the BG (To be enclosed along with the technical Bid).</p> <p style="text-align: center;">OR</p> <p>Firms who are registered with Start-ups as recognized by Department for Promotion of Industry and Internal Trade (DPIIT), holding valid Startup Recognition Certificate/ Micro and Small Enterprises (MSEs) who are holding valid Udyam Registration and are manufacturer of the offered Product or Service, are exempted from payment of EMD but these firms should submit a copy of the registration along with the Technical Bid. <i>(The certificate should be valid for at least 6 months from the date of submission of bids).</i></p> <p>Note: The exemption shall not apply to traders, agents, dealers, distributors, or firms engaged in works contracts, even if they are registered under MSE.</p> |

| | | |
|--|--|--|
| | | OR |
| | | In place of a Bid security, Bidders can submit Bid securing declaration as per Form VI accepting that if they withdraw or modify their Bids during the period of validity, or if they are awarded the contract and they fail to sign the contract, or to submit a performance security before the deadline defined in the request for bids document, they will be suspended for the period of 1 year from the date of opening of this bid from being eligible to submit Bids for contracts with the ICAT that invited the Bid. |

| | | |
|----|-------------------------------|-----------------------------------|
| 3. | Delivery Period including I&C | Within 16 weeks after issue of PO |
|----|-------------------------------|-----------------------------------|

Bidders must comply to the provision of:

- a) Rule 144 (xi) of GFR 2017 (refer Office Memorandum of Department of Expenditure dated 23rd July 2020 and as revised from time to time (**enclose declaration to this effect with the technical bid as per format given in Declaration 5 under Form IV**)
[https://doe.gov.in/files/procurement-policy-division/Amendment to Rule 144 xi of the GFRs 2017.pdf](https://doe.gov.in/files/procurement-policy-division/Amendment%20to%20Rule%20144%20xi%20of%20the%20GFRs%202017.pdf)
- b) Department of Industrial Policy and Promotion (DIPP) vide No. P-45021/2/2017-PP (BE-II) dated 04.06.2020 and as revised from time to time (**enclose declaration to this effect with the technical bid as per format given in Declaration 4 under Form IV**)
<https://dpiit.gov.in/sites/default/files/PPP%20MII%20Order%20dated%204th%20June%202020.pdf>

ICAT Bank Details for NEFT (incase any bidder deposits the EMD of Rs. 79,680 /- through NEFT)

HDFC Bank Details (Saving A/c for transactions in INR Only):-

| | |
|------------------|--|
| Beneficiary Name | International Centre for Automotive Technology |
| Bank Name | HDFC Bank Ltd. |
| Branch | Plot-K, Sector-2, Manesar-122050 Haryana |
| Account No. | 05891450000118 |
| Account Type | Saving |
| RTGS IFSC Code | HDFC0000589 |
| Swift Code | HDFCINBB |
| MICR Code | 110240079 |

ICAT और साइट के बारे में जानकारी / About ICAT & Site Description

About ICAT

The International Centre for Automotive Technology, established in 2006, setup by NAB (National Automotive Board) erstwhile NAB (National Automotive Board), under Ministry of Heavy Industries, Govt. of India is the leading automotive R&D organization of the country. ICAT is a prime Testing and Certification Agency notified by Government of India under Rule 126 of Central Motor Vehicle Rules, 1989.

Site Description:

- Location: International Centre for Automotive Technology (Centre-I), Plot No. 26, Sector - 3, Near HSIIDC Office, IMT Manesar, Gurugram - 122050 (Haryana)
- Installation site: Component Test Lab
- Utilities such as electricity, compressed air, and control room will be provided by ICAT separately.

Chapter - 2

काम का दायरा, विस्तृत तकनीकी विनिर्देश और स्वीकृति मानदंड / Scope of Work, Detailed Technical Specification, and Acceptance Criteria

The Director, International Centre for Automotive Technology (ICAT), a division of the National Automotive Board (NAB), Govt. of India, hereby invites a proposal for “**Upgradation of Controller and Software of Test Machines (Emergency Locking Retractor, Retractor Durability, Microslip/Abrasion and Bus Window Durability Test Rigs.)** in Component Test Lab (CTL) at ICAT Centre- I, Manesar, Haryana”.

| Description | Quantity | Delivery Location | Target Completion period from the date of award of Purchase Order/LOI |
|--|--------------|----------------------|---|
| Upgradation of Controller and Software of Test Machines in Component Test Lab (CTL) at ICAT Centre- I, Manesar, Haryana | | | |
| Emergency Locking Retractor Test Rig | 1 No. | ICAT Centre I | 16 weeks |
| Retractor Durability Test Rig | 1 No. | | |
| Microslip/Abrasion Test Rig | 1 No. | | |
| Bus Window Durability Test Rig | 1 No. | | |

Note: For Details & Other Technical Specification Required pertaining to this tender, kindly refer to Chapter 2 (Technical Specifications of Upgradation of Controller and Software of Test Machines Section.

Calibration

Equipment shall be supplied with all the required calibration certificates.

All measuring devices shall be calibrated, and traceable calibration certificates shall be available by the time of pre-acceptance and shall be included in the documentation delivered by the supplier from any authorised NABL Laboratory along with OEM Calibration certificate if applicable.

Calibration plan shall be included.

Arrangement of calibrated material for the pre acceptance and final acceptance is the responsibility of the equipment supplier. Calibration tools and plan need to comply with International Standards and Accreditation.

Health & Environmental Requirements

All above equipment's must meet the Environmental, Health and Safety aspects (CE or equivalent). Certificates shall be included in the Documentation. If hazardous material is used, please provide MSDS (Material Safety Data Sheet)

Documentation

At the time of equipment delivery, the supplier is required to provide at least a manual in English containing description of the equipment with detailed drawings, instructions on the operation of the system, detailed software control commands, safety organs/disturbances and possible causes, and full maintenance details.

Calibration certificates shall be included in the documentation.

Documentation shall be delivered in 2 Hard Copies and in 2 Soft Copies (Pen drives)

Installation

The Supplier shall deploy an Implementation Team with demonstrable skills and experience in order to achieve the requested quality of Installation.

The work plan proposed by the Bidder for the implementation of the equipment needs to justify that it will be suitable for achieving the installation of the Scope of Supply

The work is to be completed within stipulated time from the date of award of contract by way of Letter of Acceptance, as mentioned in the milestones appearing above.

Bidder is required to submit a detailed timing plan that shall include all phases of design, manufacture, installation and commissioning for ICAT.

The Bidder is also required to deliver, together with its Offer, a detailed implementation layout indicating the placement of their equipment along with the existing set-up in the testing area. This layout shall be according to the existing lab Layout.

The Bidder for this tender is responsible for integration of the equipment's if applicable in this tender with the existing System at ICAT. The bidder shall discuss their interfacing requirements with respective OEMs directly. Please Note, ICAT will not be part of any discussion or will not be responsible for any integration issues and the sole responsibility of integration lies with the bidder itself. ICAT can only help in coordinating if requested by bidder.

The Bidder shall be required to work out details of interfaces and submit the detailed project stating all requirements at the time of bid submission.

Exclusions (If required)

ICAT will provide electrical supply (via local isolators), water, fuels and compressed air to enable the equipment commissioning. It will be the responsibility of the equipment supplier to make all the connections from these service points to the equipment.

Service Support

The Bidder is required to have a service support set up in India with sufficient trained manpower. The Bidder shall commit a maximum response time of 24 hours, which means that in case of any breakdown within 24 hours, the Bidder's personnel should reach the site, assess the cause of the breakdown, take necessary action to resolve the issue and submit the corrective actions schedule.

Warranty

The Bidder shall be required to provide a comprehensive warranty of two years from date of final acceptance, for equipment supplied under this tender, including the following:

- The Bidder shall commit cumulative down time not exceeding 300 natural hours a year including the time required for preventive maintenance and irrespective of the working hours.

- Any preventive maintenance and / or repair for breakdown shall be carried out by the Bidder at his own cost. No charge on this account (including cost of calibration, spare parts, wear parts, consumables to be changed during maintenance, travel and accommodation expenses, etc.) will be borne by ICAT.
- The preventive maintenance will be carried out by manufacturer’s personnel, at a frequency specified by the Bidder at time of Technical Bid Submission.
- Every six months, the manufacturer’s representative will be required to inspect the equipment and submit a report on overall health & maintenance status of the equipment at least till the warranty period.

As required in the conditions above, the Bidder shall include under the Warranty conditions both preventive and corrective maintenance during the Warranty period. This includes all scheduled preventive maintenance, as well as assistance in case of breakdown, not limited to the scheduled visits, but committing to the 24 hours response time after breakdown is reported, independently from the cause of the breakdown. Both spare parts and labour shall be covered by these conditions in case of breakdown happening due to normal use of the facilities, and in no case ICAT shall not be charged for labour costs associated to any kind of breakdown during this Warranty period.

Installation, Commissioning and Training

During Acceptance of the equipment at ICAT, ICAT team (Both Technical & Maintenance) shall be trained on the job. As the part of installation and commissioning training, the Maintenance team of ICAT shall be trained by the bidder on the installation procedures, and commissioning and regarding the maintenance of the equipment. The operational team shall also be trained on the commissioning of the facilities and on the actual job that proposed to be executed with such facilities.

Technical Specifications of Upgradation of Controller and Software of Test Machines (BUS WINDOW DURABILITY TEST RIG, EMERGENCY LOCKING RETRACTOR TEST RIG, RETRACTOR DURABILITY TEST RIG & MICROSLIP/ABRASION TEST RIG):

| Sr. No. | Technical Parameter | Technical Specifications |
|---------|---------------------------------------|---|
| 1 | Reference Standards (With Amendments) | IS 15140:2018, ECE R16 & AIS 068: 2005 with Amendment No. 1 2009. |
| 2 | Bus Window Durability Test Rig | Test Standard: AIS 068: 2005 with Amendment No. 1 2009. Force: 100 N. Stroke: 300 ± 20 mm. Actuation frequency: 0.5 - 2 Hz. |
| 3 | Emergency Locking Retractor Test Rig | Test Standard: IS 15140:2018 & ECE R16. Actuator: 1500 N (2 Nos.). Accelerometer capable of developing an acceleration increase of 25 to 150 g/s (Model No. 1201F-0050-10-240X, Sr. No. A005454) Angle Mark: 12 Deg., 27 Deg., & 40 Deg. Test rig should be able to measure the displacement of webbing at defined g-value. |

| | | |
|---|--------------------------------|--|
| | | Servo-Controlled Acceleration & Displacement measurement & Rotary servo mechanism for angular control. |
| 4 | Microslip/Abrasion Test Rig | Test Standard: IS 15140:2018 & ECE R16. Weights: 250 N, 200 N & 50 N |
| 5 | Retractor Durability Test Rig. | Test Standard: IS 15140:2018 & ECE R16. Fast actuation for snatches. Actuation frequency: 0.5 - 2 Hz. |
| 6 | Scope of Work | <p>Individual controller (HMI) & software for all four machines and their software to be installed in one PC for data logging so that no machine will depend on others.</p> <p>A) Bus Window Durability Test Rig:</p> <p>Major Items Required as below:</p> <ol style="list-style-type: none"> 1. HMI (Screen size - min. 10 inch) Controller with PLC & software - 1 No. 2. Any mounting to support hardware - 1 Set 3. Load Cell of 600 N 4. All electrical, communication & any other cables etc. 5. Tower light with buzzer. 6. Electrical Panel. <p>Any other item except above in order to run the equipment, is the responsibility of supplier.</p> <p>B) Automation of Emergency Locking Retractor Test rig: Currently, desired g level is being achieved after trail & error method with adjusting the pressure manually and measurement of strap movement is being done manually. Need to modify the software as well as hardware (if required) so that desired g level, strap movement & rotation of Safety Belt Assembly will be achieved automatically through servo control.</p> <p>Major Items Required as below:</p> <ol style="list-style-type: none"> 1. Servo system (For g measurement) - 1 No. 2. Servo system (For strap movement) - 1 No. 3. HMI (Screen size - min. 10 inch) Controller with PLC & software - 1 No. 4. LVDT - 1 No. 5. Load Cell with controller - 1 No. 6. Any mounting to support hardware - 1 Set |

| | | |
|---|--|---|
| | | <p>7. Servo Motor for Rotary movement of Safety Belt Assembly.</p> <p>8. All electrical, communication & any other cables etc.</p> <p>9. Tower light with buzzer.</p> <p>10. Electrical Panel.</p> <p>Any other item except above in order to run the equipment, is the responsibility of supplier.</p> <p>C) Microslip/Abrasion Test Rig:</p> <p>Major Items Required as below:</p> <ol style="list-style-type: none"> 1. HMI (Screen size - min. 10 inch) Controller with PLC & Software - 1 No. 2. Any mounting to support hardware - 1 Set 3. All electrical, communication & any other cables etc. 4. Tower light with buzzer. 5. Electrical Panel. <p>Any other item except above in order to run the equipment, is the responsibility of supplier.</p> <p>D) Retractor Durability Test Rig:</p> <p>Major Items Required as below:</p> <ol style="list-style-type: none"> 1. HMI (Screen size - min. 10 inch) Controller with PLC & Software - 1 No. 2. Servo system with mountings - 1 Set. 3. Any mounting to support hardware - 1 Set 4. All electrical, communication & any other cables etc. 5. Tower light with buzzer. 6. Electrical Panel. <p>Any other item except above in order to run the equipment, is the responsibility of supplier.</p> <p>E) Industrial PC (latest) compatible for Software & data storage along-with color printer</p> <p>Any other item except above in order to run the equipment, is the responsibility of supplier.</p> |
| 7 | Brief Description of Testing method (Refer Figure - I for photographs of existing machines). | <p><u>Life cycle test for bus windows:</u></p> <p>The window shall withstand 7,000 open close cycles at a force between 50 and 75 N. with a performance degradation not exceeding 15%.</p> |

Emergency locking for safety belt retractors:

A specific machine shall be included for this test.

The following description is done in the standard. Any other option that allows the tests to be performed as per the standard's requirements shall also be accepted:

A suitable apparatus is illustrated in the figure and consists of a motor-driven cam, the follower of which is attached by wires to a small trolley mounted on a track. The cam design and motor speed combination shall ensure that the required acceleration is given before the webbing is withdrawn out of the retractor by more than 5 mm and that the withdrawal takes place at an average rate of increase of acceleration of at least 25 g/s and not more than 150 g/s and the stroke is arranged to be in excess of the maximum permitted webbing movement before locking.

On the trolley a carrier is mounted which can be swivelled to enable the retractor to be mounted in varying positions relative to the direction of movement of the trolley.

The seat belt retractors should not block under around 0.75gs and block over 2gs

When testing retractors for sensitivity to strap movement the retractor is mounted on a suitable fixed bracket and the strap is attached to the trolley.

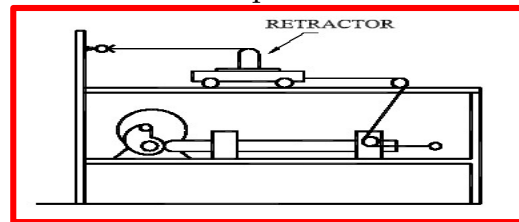

Micro slip test for safety belt straps:

The strap shall be subjected to a load of 50 N. at one end. At the other end, the strap shall be pulled and released back and forth with 300 mm ± 20 mm. of amplitude in a 2 Hz. cyclic movement. The load shall only be applied for 100 ± 20 mm. Therefore, the ballast shall touch the ground after 100 ± 20 mm.

Durability test for retractors of safety belts:

The following description is as per standard.

Durability of retractor mechanism

The strap shall be withdrawn and allowed to retract for the required number of cycles at a rate of not more than 30 cycles per minute. In the case of emergency locking retractors, a snatch to lock the retractor shall be introduced at each fifth cycle.

The snatches shall occur in equal numbers at each of five different extractions, namely, 90, 80, 75, 70 and 65 per cent of the total length of the strap remaining wound on the retractor. However, where more than 900 mm is provided the above percentages shall be related to the final 900 mm of strap which can be withdrawn from the retractor.

A suitable apparatus for the tests specified in paragraph above is shown below

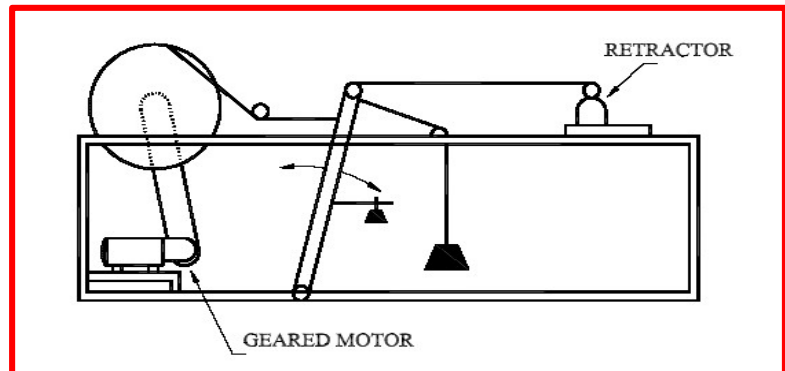

| | | |
|----|---|--|
| 8 | Installation & Commissioning | The supplier shall install the software & hardware in above mentioned Test Rigs at ICAT Manesar. Also, the supplier shall demonstrate the working of Software with Trials in order to complete the Commissioning Process |
| 9 | List of Documents/Calibration Certificates Required | The supplier shall submit the following documents: - <ul style="list-style-type: none"> ❖ Operation Manual of Rig [02 Hard Copies] ❖ Technical Manual with all mechanical drawings & electrical circuit diagram [02 Hard Copies] ❖ Software CDs (1 Nos.) ❖ The manual, drawings & Circuits on a CD [Optional] ❖ Calibration Certificates (Traceable to NPL/NABL Accredited Lab). |
| 10 | Warranty | The supplier shall provide the warranty for 2 years min. from Acceptance of Software. |

| | | |
|----|--|--|
| 11 | Technical Support/After Sales Services | The supplier shall provide technical support in case of any fault/breakdown of software. Also, after the expiration of warranty period the supplier must be capable to handle Comprehensive AMC for complete software. |
|----|--|--|

Figure I (Photographs)



Emergency Locking Retractor Test Rig



Bus Window Durability Test Rig



Microslip/Abrasion Test Rig



Retractor Durability Test Rig

Other General Requirements

- Representative details including company address and email ID shall be submitted for all the equipment.
- Service manual indicating maintenance and operation of all critical parts shall be submitted.
- Preventive maintenance plan for all critical equipment shall be proposed in manual.
- The license of all supplied software (if applicable) should be valid for lifetime (perpetual licence). Free upgrades and on - site maintenance/support shall be included minimum for warranty period i.e. 2 years.

- **Source code shall be supplied separately.**
- The license to software shall be floating so that it can be used on backup PC in case of emergency.
- All wiring, cables, conduits etc. shall be arranged properly around the machine such that it does not affect the man movement around the machine.
- One set of Operation Manual with operating instruction illustrated with sketches of operating parts, parts list (with part codes), diagrams with list ratings of components and list of dos and don'ts for the main equipment as well as the sub-systems.
- These manuals should be in the form of hard (printed) copy in English Language as well as in electronic storage form (disc, pen drive etc.).
- Any protection/isolation devices deemed necessary shall be included.

Acceptance Criteria

- Successful completion of Factory Acceptance Test (FAT)/Pre-Delivery Inspection (PDI) witnessed by ICAT representatives.
- Successful Site Acceptance Test (SAT) at ICAT including trial runs and compliance verification as per standards.
- Delivery of manuals, drawings, calibration certificates, and training completion.
- Warranty & service obligations in force after acceptance.

Other Technical Conditions:

1. **Clarifications, Deviations, and Conditional Bids:** Bidders are strictly advised to submit their bids in full compliance with all terms, conditions, technical specifications, and requirements stipulated in this tender document. Conditional bids or bids containing deviations, exceptions, assumptions, or qualifications shall be summarily rejected without further reference or clarification, at the sole discretion of the Purchaser.

Any suggestions, clarifications, or concerns regarding the tender terms and conditions must be formally raised by the Bidders only during the Pre-Bid Meeting. The Purchaser shall review such requests and reserves the absolute right to accept, modify, or reject any suggestion or concern, wholly or in part, without assigning any reason, and solely in the best interest of the Purchaser.

All clarifications, amendments, or modifications arising out of the Pre-Bid Meeting shall be published either as a Corrigendum and/or as the Minutes of the Pre-Bid Meeting (MoM) on the Purchaser's official website (www.icat.in) and on the GeM Portal. These shall form an integral part of the tender and shall be binding on all Bidders. No request for changes or deviations shall be entertained after the Pre-Bid stage.

2. **Product Lifecycle Assurance and Post-Supply Support Commitment:** The Bidder shall ensure comprehensive service and technical support for all equipment supplied for a minimum **period of ten (10) years from the date of final acceptance**. The products offered must not be classified as 'end-of-life' or 'end-of-sale' as of the date of final acceptance. If the manufacturer discontinues or withdraws support for any quoted product prior to delivery, the Supplier shall, at no additional cost to the

Purchaser, provide a replacement product of equal or superior quality, specifications, and functionality. Such replacement shall be subject to the Purchaser's approval and shall ensure continuity of operations without any disruption to project requirements.

- 3. Proposal Submission Compliance and Documentation Requirements:** The Bidder is required to submit their proposal in strict compliance with all terms, conditions, and technical requirements outlined in this tender document. The technical bid must include comprehensive details of the proposed solution, including the products, services, specifications, and relevant technical literature, clearly demonstrating conformance to the specified requirements. A Statement of Compliance, in the format prescribed within the Technical Specifications, shall be submitted for each item listed. Each compliance statement must be substantiated with authentic, verifiable documentation (e.g., brochures, datasheets, certifications) issued by the Original Equipment Manufacturer (OEM) or other credible sources. Furthermore, each page of the bid, including any amendments, corrections, or insertions, must be duly signed and stamped by the authorized signatory of the Bidder, thereby certifying its accuracy and authenticity. Failure to adhere to any of the above requirements may render the bid liable for rejection at the sole discretion of the Purchaser.
- 4. Delivery, Installation, and Commissioning Timeline:** The Supplier shall be responsible for the complete delivery, installation, and commissioning of all items in accordance with the specifications and scope defined in this tender. This includes the submission of all requisite warranty documents and associated deliverables. The entire process, comprising delivery, installation, commissioning, and handover of warranty documentation, must be completed with the timelines as per this tender. Timely execution of all activities within the stipulated period is of the essence. Any delay beyond the specified timeline shall attract penalties and other contractual remedies as prescribed in the tender terms and conditions
- 5. Liquidity Damages (LD Condition):** In the event of a delay in delivery, installation, or commissioning beyond the stipulated timelines, and where such delay is not attributable to the Purchaser, the Supplier shall be liable to pay Liquidated Damages (LD) to the Purchaser. The LD shall be levied at the rate of 0.5% (half percent) of the total contract value for each week or part thereof delay, subject to a maximum ceiling of 10% (ten percent) of the total contract value. The imposition of LD shall not limit or restrict the Purchaser's right to terminate the contract or pursue any other remedies available under law or contract.
- 6. Warranty Terms and Conditions:** The Supplier shall provide a comprehensive warranty for all equipment, components, and software supplied under this contract for a period of twenty-four (24) months from the date of final acceptance by the Purchaser. During the warranty period, the Supplier shall, at no additional cost to the Purchaser, promptly repair or replace any part of the equipment or system that is found to be defective in material, workmanship, or performance under normal operating conditions. This includes, but is not limited to, the cost of labour, transportation, travel, accommodation, tools, and replacement parts.

The warranty shall cover all supplied hardware, software, firmware, integrated systems, and associated components, and shall ensure their uninterrupted and optimal performance in accordance with the technical requirements and specifications outlined in the contract.

The Supplier shall respond to warranty claims within 24 hours of notification by the Purchaser and shall rectify the issue within a reasonable period as mutually agreed, failing which the Purchaser

reserves the right to undertake rectification through a third party at the risk and cost of the Supplier, without prejudice to any other rights available under the contract.

The warranty obligations of the Supplier shall survive the expiration or termination of the contract to the extent that such obligations arose during the warranty period.

Any exclusion or limitation of warranty not expressly stated in this contract shall be deemed invalid. The Supplier shall ensure that warranty terms and obligations are similarly extended by any subcontractors or original equipment manufacturers involved in the supply.

7. Assignment and Subcontracting: The Contractor shall not, without the prior written consent of the Procuring Entity, sublet, transfer, assign, or otherwise dispose of the contract or any part thereof, or any interest, benefit, or advantage arising therefrom, in any manner whatsoever. The Contractor shall provide written notification to the Procuring Entity of all subcontracts awarded under this contract, if such subcontracts were not already disclosed in the original bid or contract. Such notification shall not absolve the Contractor of any liability or obligation under the contract. Subcontracting shall be permitted solely for the procurement of bought-out items and incidental works or services. All subcontracts must fully comply with the Contractor's obligations under this contract and shall not be used to circumvent the Contractor's responsibilities or obligations that formed the basis for the award of this contract. Any assignment, subletting, or transfer of this contract, or any part thereof, made without the prior written consent of the Procuring Entity shall constitute a material breach of contract. In such an event, the Procuring Entity shall have the right to invoke any or all remedies available under the contract or applicable law.

8. Performance Security: Within fifteen (15) calendar days from the date of award of the Contract on the GeM Portal, the Supplier shall furnish a Performance Security in the form of either a Performance Bank Guarantee (PBG) or a Fixed Deposit Receipt (FDR) or online payment via NEFT/RTGS amounting to five percent (5%) of the total Contract value. Performance Security shall be submitted in favour of the Purchaser "International Centre for Automotive Technology" and must remain valid for a period extending up to the completion of the warranty period, i.e., Twenty-Four (24) Months from the date of final acceptance of the supplied goods and services, plus an additional claim period of sixty (60) days thereafter.

In the case of a Performance Bank Guarantee, it shall be issued by a branch located in Delhi/NCR of any Indian Scheduled Bank and shall be strictly in the format prescribed by the Purchaser.

The Performance Security shall be liable for forfeiture, in the event of the Supplier's failure to fulfill its contractual obligations, including but not limited to delays in delivery, defective performance, or breach of warranty terms.

Failure to submit the required Performance Security within the stipulated period shall constitute a material breach of contract, entitling the Purchaser (i.e., ICAT) to take any action deemed appropriate, including but not limited to cancellation of the contract, encashment of the Earnest Money Deposit (EMD), and initiation of penal or legal proceedings, in accordance with the terms and conditions of the tender and applicable laws.

Performance Security amount shall be held by ICAT interest-free and shall be released to the Supplier only upon the successful completion of all warranty obligations as defined under the contract. No interest shall be payable on the Performance Security under any circumstances.

9. Service Support: The Bidder is required to have a service support set up in India in preferably vicinity to

ICAT with sufficient trained manpower.

The Bidder shall commit a maximum response time of 24 hours, which means that in case of any breakdown within 24 hours, the Bidder's personnel should reach the site, assess the cause of the breakdown, take necessary action to resolve the issue and submit the corrective actions schedule.

Successful bidder must provide onsite repair (all type of repairs) for the supplied equipment include all type of expenditure incurred for same.

The bidder shall also provide a direct contact point to be used for Service Support, should ICAT require to, anytime during the equipment lifetime.

10. Payment Terms:

- 60 % of the total contract price shall be paid within fifteen [15] days from the receipt of defect free equipment at site, in good condition.
- 20% of the total contract price shall be paid against successful installation & commissioning.
- 20% of the total contract price shall be paid after acceptance.

Note: Above payments will be released by ICAT only after receipt of PBG @5% of the contract value within 15 days from the issue of LOI/contract/PO as per clause no. 8 of chapter 2 this ATC and confirmation of above payment milestones. Further the payment mentioned above are subject to deduction of all statutory taxes i.e. TDS, WCT, GST, Service Tax etc. as applicable.

11. Material Safety and Storage Conditions:

The Supplier shall be solely responsible for ensuring the safety, proper handling, and secure storage of all materials, equipment, and components supplied under this Contract until the point of final acceptance by the Purchaser. All materials must be packed, transported, and stored in accordance with applicable industry standards, manufacturer guidelines, and statutory safety regulations to prevent any damage, deterioration, contamination, or loss.

The Supplier shall take all necessary precautions during transit and storage to preserve the quality, integrity, and performance of the materials, including but not limited to the use of protective packaging, climate control (where required), handling equipment, and security measures.

In the event that any material is damaged, lost, or rendered unusable due to improper handling, inadequate storage, or negligence on the part of the Supplier or its agents, such materials shall be replaced or restored by the Supplier at no additional cost to the Purchaser, without affecting the delivery schedule.

If storage space at the Purchaser's site is required prior to installation, the Supplier shall seek prior written approval and shall comply with all site-specific safety and access protocols. Storage at the Purchaser's premises, if permitted, shall be at the Supplier's risk and shall not constitute acceptance of the goods by the Purchaser.

All hazardous materials, if any, shall be clearly identified, labeled, and accompanied by relevant Material Safety Data Sheets (MSDS) and safety instructions in accordance with applicable laws and best practices.

12. Manpower Insurance and Liability:

The Supplier shall ensure that all personnel, including employees, agents, subcontractors, or any other individuals deployed for the execution of this Contract, are adequately insured against all risks, including but not limited to accidents, injury, disability, or death, as per applicable statutory and regulatory requirements.

The Supplier shall maintain valid insurance policies throughout the duration of the project and shall furnish evidence of such insurance coverage to the Purchaser upon request.

The Purchaser shall bear no responsibility or liability whatsoever for any accident, injury, illness,

disability, death, or any other mishap occurring to the Supplier's personnel during the course of their engagement on this project. The Supplier agrees to indemnify, defend, and hold the Purchaser harmless from and against any and all claims, demands, liabilities, damages, fines, penalties, costs, and expenses arising out of or in connection with any such incidents.

It is expressly understood that the Supplier shall be solely responsible for complying with all applicable laws, rules, and regulations relating to the employment, safety, welfare, and insurance of its manpower.

- 13. Delivery and Insurance Instructions:** The Supplier shall be solely responsible for the safe and timely delivery of all goods, equipment, and materials covered under this Contract to the designated delivery location specified by the Purchaser. Delivery shall be made strictly in accordance with the delivery schedule and milestones stipulated in the Contract.

All items must be securely packed, handled, and transported in a manner that ensures protection against damage, corrosion, pilferage, or deterioration during transit and storage. The Supplier shall be liable for any damage or loss occurring before the formal receipt and acceptance of goods by the Purchaser.

The Supplier shall, at its own cost, arrange comprehensive transit insurance covering the full value of the goods against all risks from the point of dispatch to the point of final delivery at the Purchaser's site. The insurance policy shall be issued by a reputed insurer and shall remain valid until the goods are successfully delivered, inspected, and acknowledged by the Purchaser.

The offloading/unloading of all materials at the project site shall be the sole responsibility of the Supplier and shall be carried out in a safe, careful, and timely manner, using appropriate equipment and manpower. The Purchaser shall not provide any assistance or bear any cost associated with the offloading of materials at the site.

Any shortage, damage, loss, or deterioration noticed at the time of delivery shall be promptly rectified or replaced by the Supplier at no additional cost to the Purchaser, without affecting the delivery schedule.

The risk and responsibility for the goods shall remain with the Supplier until the materials are delivered to, offloaded at, inspected, and formally accepted in writing by the Purchaser.

14. Pre-Delivery Inspection (PDI)

- A. Purpose and Scope:** Prior to delivery, the Supplier shall organize a Pre-Delivery Inspection (PDI) of the equipment at the Supplier's premises or at any other location mutually agreed upon by the Parties. The objective of the PDI shall be to verify compliance with the technical specifications, quality standards, and other contractual obligations as set forth in this Tender Document and the ensuing Contract.
- B. Notification and Participation:** The Supplier shall provide the Purchaser with a written notice of at least thirty (30) calendar days prior to the scheduled PDI, to enable the Purchaser or its authorized representative(s) to attend and participate in the inspection. During the PDI, the Purchaser shall have the right to inspect, test, and verify the performance and conformity of the equipment and all related components. Any defects, non-conformities, or deficiencies identified during the PDI shall be rectified by the Supplier at no additional cost to the Purchaser prior to shipment. The equipment shall only be deemed ready for dispatch upon successful completion of the PDI and formal written approval from the Purchaser.
- C. Right to Postpone or Waive Attendance:** The Purchaser reserves the right to either not attend the PDI or Request a one-time postponement of the PDI by a maximum of fifteen (15) calendar days from the originally scheduled date, to facilitate attendance by its representative(s). In such cases, the Purchaser shall notify the Supplier in writing, no later than fifteen (15) calendar days prior to the

originally scheduled PDI date. No liquidated damages or penalties shall be imposed on either Party because of such postponement.

- D. In the event the Purchaser either formally communicates its decision not to attend the Pre-Delivery Inspection (PDI) or fails to attend the PDI on the rescheduled date, the Supplier shall be entitled to proceed with the PDI in the absence of the Purchaser's representatives. In such cases, the Certificate of Conformity and the Acceptance Test Report, duly signed by the Supplier's authorized Quality Assurance (QA) representative, shall be deemed to have the same legal force and effect as if jointly signed by both Parties.
- E. **Cost of Participation:** All expenses associated with the participation of the Purchaser's representative(s) in the PDI, including travel, accommodation, meals, and daily allowances, shall be borne solely by the Purchaser.

15. **Training Requirement:** As part of the scope of work, the supplier shall be responsible for providing comprehensive training to the relevant personnel of the purchaser, including both the Technical and Maintenance teams, during the acceptance and commissioning phase of the equipment. The training shall be conducted at the purchaser's facility or at any other mutually agreed location.

The training shall include, but not be limited to:

- **Operational Training:** The supplier should also train the Operational Team on the execution of actual jobs using the upgraded testing facilities, covering all relevant functionalities and safety protocols.
- **Maintenance Training:** The Maintenance Team shall be trained on routine and preventive maintenance procedures, troubleshooting, and general upkeep of the equipment.

Note: The duration of training shall not be less than 3 days.

The Supplier shall provide all training materials, manuals, and necessary documentation to the Purchaser in English, in both digital and printed formats, as applicable. The Supplier shall conduct the required training at no additional cost to the Purchaser, and all expenses related to such training shall be borne entirely by the Supplier.

16. **Integrity Pact:** The Parties hereby commit to uphold the principles of transparency, fairness, and integrity in the execution of this Agreement. The Contractor/Supplier agrees not to engage in any corrupt, fraudulent, collusive, or coercive practices during the course of the contract.

The Contractor/Supplier shall not offer, give, or agree to give to any person, directly or indirectly, any gift, gratuity, commission, or other thing of value as an inducement or reward in relation to the award or execution of this contract. The Parties acknowledge that a breach of this clause shall constitute a material breach of contract and may result in termination, blacklisting, or legal action as deemed appropriate by the Client/Authority.

17. **Unsatisfactory Performance:** The bidder herein agree that ICAT shall have sole and discretionary right to assess the performance(s) of the Bidder equipment(s), either primary and or final, and ICAT, without any liability whatsoever, wither direct or indirect, may reject the system(s) / equipment(s) provided by the Bidder, in part or in its entirety, without any explanation to the Bidder, either during the pre and or post test period should the same be unsatisfactory and not to the acceptance of ICAT. The Bidder covenants to be bound by the decision of ICAT without any demur in such an eventuality.

18. **Termination of Contract:** If the performance of the vendor is not satisfactory in timely delivery of item or quality of product delivered then the same will be informed in writing by ICAT as warning

letter and if in spite of issue of warning letter, the items are not delivered or quality of delivered product is not satisfactory as per expectation of ICAT within a fortnight then second warning letter will be issued.

If after issue of second warning letter also performance doesn't satisfy ICAT expectation or product not delivered, then ICAT reserves the right to terminate the work order by giving one-month notice in writing without assigning any further reason whatsoever.

After the contract becomes null and void the amount deemed payable to the vendor (if any) will sine die without any further payment. No further claim from the vendor will be entertained. After the contract comes to an end the vendor will withdraw their service/equipment from ICAT premises within a month.

Decision of competent authority of ICAT regarding determining the performance will be final.

19. **Confidential Information:** ICAT and Selected Bidder shall keep confidential and not, without the written consent of the other party hereto, divulge to any third party any documents, data, or other information furnished directly or indirectly by the other party hereto in connection with the Contract, whether such information has been furnished prior to, during or following completion or termination of contract.
20. **The tender document is not an offer and is issued with no commitment.** ICAT reserves the right to withdraw this notice inviting tender or vary any part thereof at any stage. ICAT further reserves the right to disqualify any bidder, should it be so necessary at any stage. ICAT reserves the right to reject any or all the tenders, wholly or partly without assigning any reason thereof and shall not be bound to accept the lowest tender.
21. **Law of the Republic of India are applicable to this tender.**
22. **Fraud and Corruption:** The bidders, suppliers and contractors shall observe the highest standard of ethics during bidding and during performance of the contract. For the purposes of this provision, the following acts shall be considered as corrupt and/or fraudulent practices.
 - "Corrupt Practice" means offering, giving, receiving, or soliciting directly or indirectly, of anything of value to influence the action of an official in the procurement process or in contract execution.
 - "Fraudulent Practice" means misrepresentation or omission of facts in order to execution of contract.
 - "Collusive Practice" means a scheme or arrangement between two or more bidders, with or without the knowledge of the purchaser, designed to establish bid prices at artificial, non-competitive level.
 - "Coercive Practice" means harming or threatening to harm, directly or indirectly, persons or their property to influence their participation in a procurement process or in execution of a contract.
 - During the process of evaluation of a bid or proposal for award of a contract, if it is detected that a bidder directly or through agent has engaged in corrupt, fraudulent, collusive or coercive practice in competing for the contract in question, then a) the bid shall be rejected and b) declare the firm ineligible for a specific period or indefinitely to participate in a bidding process.
 - Bidders may note that GeM is capturing and showing the IP addresses used by the Buyer and Bidder(s)/Seller(s). Bids submitted from IP addresses that are identical to or shared with other Bidders/Sellers shall be deemed invalid and automatically disqualified from further evaluation.
23. **Collusive Bidding or Bid Rigging or Cartelization:** The Bidder(s) acknowledges and agrees that any form of bid rigging, cartelization, or coordination among bidders, aimed at manipulating the bidding process or prices, is strictly prohibited. In the event of any evidence or suspicion of collusion, bid rigging, or cartel behavior, the Tendering Authority reserves the right to reject the bid(s) and take appropriate legal action, including but not limited to debarment from future tenders and reporting

to relevant authorities. Bidders are required to submit their bids independently, without any undue influence or agreement with other participants in the tender process.

24. Any Dispute/Difference arising out of or relating to this tender: In case any dispute arises between ICAT and the other party due to any term or matter, both the parties will opt to resolve it through mutual understanding and discussion. In case, dispute remains even after discussions, then it shall be binding upon parties to resolve issues under the provisions of Arbitration & Conciliation Act, 1996 as amended from time to time. Under this provision, Director, ICAT with the concurrence of both the parties shall appoint Sole Arbitrator to resolve the issue and both the parties will have to abide by the decision. The parties will bind to resolve this dispute through arbitration before going to court of law. The Arbitration shall be conducted at Gurugram and shall be in English Language. The court of Gurugram shall have the jurisdiction.

As per the Guidelines of Arbitration & Mediation in Contracts of Domestic Public Procurement issued by The Department of Expenditure Procurement Policy Division under Ministry of Finance, Govt. of India through OM No. F.1/2/2024-PPD dated 03.06.2024, the arbitration shall be restricted to disputes with a value less than Rs. 10 crore. This figure is with reference to the value of the dispute (not the value of the contract, which may be much higher). In all other cases where value of dispute is above 10 crore, arbitration will not be a method of dispute resolution in the contract.

25. **Other General Requirements:**

- Representative details including company address and email ID shall be submitted for all the equipment.
- Service manual indicating maintenance and operation of all critical parts shall be submitted.
- Preventive maintenance plan for all critical equipment shall be proposed in manual.
- The license of all supplied software (if applicable) should be valid for lifetime (perpetual licence). Free upgrades and on - site maintenance/support shall be included minimum for warranty period i.e. 2 years.
- **Source code shall be supplied separately.**
- The license to software shall be floating so that it can be used on backup PC in case of emergency.
- All wiring, cables, conduits etc. shall be arranged properly around the machine such that it does not affect the man movement around the machine.
- One set of Operation Manual with operating instruction illustrated with sketches of operating parts, parts list (with part codes), diagrams with list ratings of components and list of dos and don'ts for the main equipment as well as the sub-systems.
- These manuals should be in the form of hard (printed) copy in English Language as well as in electronic storage form (disc, pen drive etc.).
- Any protection/isolation devices deemed necessary, shall be included.

26. ICAT does not bind itself to accept the lowest tender/bid and reserves the right to reject or accept any or all the tenders/bids received without assigning any reason whatsoever.
27. Canvassing in connection with tenders/bids is strictly prohibited and the tenders/bids submitted by the bidder/bidders who resort to canvassing will be liable for rejection on that ground alone.
28. **Project Site:** International Centre for Automotive Technology (Centre-I), Plot No. 26, Sector - 3, Near HSIIDC Office, IMT Manesar, Gurugram - 122050 (Haryana)
29. **Billing Address:** International Centre for Automotive Technology (Centre-I), Plot No. 26, Sector - 3, Near HSIIDC Office, IMT Manesar, Gurugram - 122050 (Haryana), GST No. 06AABAN9435G2ZI

For or any technical queries please feel free to contact the undersigned:

Contact Person: Mr. Manish Pandey - CTL Department

Contact No.: 8585804826

Email ID: manish.pandey@icat.in

Contact Person: Mr. Amol Kumar CTL Department

Contact No.: 9891996707

Email ID: amol.kumar@icat.in

Chapter - 3

न्यूनतम पात्रता मानदंड / Minimum Eligibility Criteria

Eligibility Criteria (Pre-Qualification Requirements): Only those Bidders who meet the following pre-qualification criteria shall be considered eligible to participate in this procurement process. Bidders must provide satisfactory documentary evidence in support of each requirement listed herein. Any bid that fails to comply with or demonstrate conformance to the stipulated eligibility conditions shall be treated as non-responsive, and such bid shall be summarily rejected without further evaluation, including exclusion from the technical assessment stage.

The Purchaser reserves the right to verify the authenticity of the documents submitted and to request additional clarifications, if deemed necessary. Submission of false, misleading, or unverifiable information shall lead to immediate disqualification and may also invite further action as per applicable laws and tender conditions.

Pre-qualification/Minimum Eligibility Criteria for the Bidders:

- 1. Legal Valid Entity:** The bidder shall necessarily be a legal valid entity in the form of a proprietary firm, partnership firm, private limited company, or agency (enclose a copy of the registration or incorporation certificate with the technical bid).

In support of above, the bidder is required to submit the following documents with the technical bid:

- **Proprietary Firm:** A copy of the registration certificate or any relevant document that proves the establishment and legal validity of the proprietary firm.
- **Partnership Firm:** A copy of the Partnership Deed along with the registration certificate issued by the Registrar of Firms, if applicable.
- **Private Limited Company:** A copy of the Certificate of Incorporation issued by the Registrar of Companies (RoC) along with the Memorandum of Association (MOA) and Articles of Association (AOA).
- **Agency:** A copy of the registration certificate or any official document proving the legal validity and registration of the agency under the applicable law (e.g., registration under the Shops and Establishments Act, or other relevant legislation).

These documents should be enclosed along with the technical bid to demonstrate the legal status of the bidder as a valid entity.

- 2. Legal Presence in India:** The Bidder must be a legal entity registered and operating in India. The Bidder shall have a valid legal presence in India as per applicable laws and must be authorized to conduct business in the country. Proof of such legal presence, including a valid Certificate of Incorporation/Registration, PAN, and GST registration, must be submitted along with the bid.
- 3. The bidder should be either an OEM/OES or his authorized channel partner**

The bidder must be either:

- the Original Equipment Manufacturer (OEM),
- the Original Equipment Supplier (OES),

- an authorized channel partner duly appointed by the OEM.

In cases where the bidder is not the OEM, the bidder shall be required to submit a valid authorization letter or certificate from the respective OEM, clearly authorizing the bidder to participate in this tender and to carry out the specified scope of work. Failure to submit the required authorization or submission of invalid/expired documentation shall render the bid non-responsive and liable for disqualification.

- 4. Experience Requirement:** The Bidder must have a minimum of three (3) years of experience.
- 5. Prior Experience Requirement:** The bidder should have successfully supplied and installed at least 1 same/similar equipment mentioned in Chapter 2, during last three years.

To qualify under 'similar nature of work,' the previously supplied machines which were controlled through PLC for parameters like G values (same or more g-values) with displacement measurement or PLC Controlled Servo actuators or PLC controlled durability cycle test rigs.

- 6. References:** The Bidder is requested to provide at least 1 reference same/similar to equipment range mentioned in the Chapter 2 included in this tender, handled by them during last three years, meaning supply and installation. These are to be included in Form IX.
- 7. Financial Capability:** The bidder must have an average annual turnover of at least 1.20 Crores in the last three consecutive FY's (2022-23, 2023-24 and 2024-25). The bidders must submit Audited Balance Sheet duly certified by the Chartered Accountant/Certificate from Chartered Accountant indicating the turnover for the last 3 consecutive financial years (FY 2022-23, 2023-24 & 2024-25). The contact details of CA/Statutory Auditor along with **UDIN No.** shall be mandatorily mentioned on copy of certified Balance Sheet/Certificate.
- 8. Undertaking Regarding Non-Blacklisting:** The Bidder must not have been blacklisted, debarred, or declared ineligible for participation in any public procurement by any Ministry or Department of the Government of India, any State Government, Public Sector Undertaking (PSU), Autonomous Body, or any reputed private organization or institution in India, as on the date of submission of the bid. The Bidder shall submit a duly signed and stamped declaration to this effect as per the prescribed format enclosed in the tender document. Failure to disclose such information or submission of a false declaration shall lead to immediate disqualification of the bid and may result in further action, including blacklisting, as deemed appropriate by the Purchaser.
- 9. Bidders to Comply with:**
 - Rule 144(xi) of GFR 2017 regarding restrictions on procurement from a bidder of a country that shares a land border with India will be liable to rejection (refer to the to the Office Memorandum of the Department of Expenditure dated July 23, 2020, and as revised from time to time at <https://doe.gov.in/sites/default/files/OM%20dated%2023.07.2020.pdf>).
 - Department of Industrial Policy and Promotion (DIPP) vide No. P-45021/2/2017-PP (BE-II) dated 04.06.2020 and as revised from time to time regarding bidders eligibility and preference to make in India (<https://dpiit.gov.in/sites/default/files/PPP%20MII%20Order%20dated%204th%20June%202020.pdf>).

Note:

- ICAT reserves the right to give preference to the local supplier, MSME, or start-up as per prevailing government notifications and as revised from time to time.
- MSE Public Procurement Policy is meant for the procurement of only goods produced and services rendered by MSEs. However, traders, distributors, sole agents, and works contracts are excluded from the purview of the Public Procurement Policy for MSEs Order, 2012.
- ICAT, at its sole discretion, may relax the requirements of prior turnover and prior experience for start-up enterprises recognized by the Department for Promotion of Industry and Internal Trade (DPIIT), provided that such entities fully comply with all quality standards, technical specifications, and performance criteria as specified in the tender documents. Such start-ups may be MSMEs or otherwise. Only registered Micro and Small Enterprises (MSEs) and DPIIT-recognized start-ups shall be considered for relaxation under this provision. Any such relaxation shall be strictly conditional upon the enterprise's demonstrated capability to meet all functional, operational, and contractual requirements of the tender. This relaxation shall be applied in accordance with the provisions of applicable government policies and shall not compromise adherence to the tender's prescribed technical, quality, or performance requirements. ICAT's decision in this regard shall be final and binding.

Note: In case of any deviation with respect to our tender conditions, the same to be filled in deviation form by the bidders as per Form X and must be raised 10 days prior to bid submission date via GeM by raising the representation. No claim shall be entertained afterwards

बोली अस्वीकार करने के मानदंड / Bid Rejection Criteria

Bidders are required to adhere strictly to all terms, conditions, and eligibility requirements outlined in this tender document. Failure to comply with any of the following conditions shall render the bid liable for rejection at any stage of the evaluation process, at the sole discretion of the Purchaser

1. **Non-Submission of Authorization Certificate:** Failure to submit a valid and duly signed Authorization Certificate from the Original Equipment Manufacturer (OEM), wherever applicable.
2. **Non-Compliance with Bid Security Requirements:**
 - Non-submission of the valid **Earnest Money Deposit (EMD)**, or
 - Non-submission of the Bid Security Declaration in the prescribed **format**, or
 - Non-submission of a valid **Udyam Registration Certificate for Micro & Small Enterprises (MSEs) or Startups** seeking exemption from EMD under the Public Procurement Policy. Enterprises claiming such exemption must submit a copy of valid **Udyam Aadhaar Memorandum (UAM) or Udyam Registration Certificate or startup certificate** with the Technical Bid to be eligible for consideration.
 - **Failure to Meet Financial Turnover Requirement:** Bidders must have an average annual turnover of not less than **INR 1.2 Crores** during the **last three (3) consecutive financial years (FY 2022-23, 2023-24, and 2024-25)**. Audited Balance Sheet duly certified by the Chartered Accountant/Certificate from Chartered Accountant indicating the turnover for the last 3 consecutive financial years, must be submitted. Failure to provide such documentation shall result in rejection of the bid.
3. Not demonstrating technical capability/ expertise in the field of our requirement as per tender.
4. **Non-Submission of Statutory Registrations:** Bidders must submit valid copies of their Goods and Services Tax (GST) registration and Permanent Account Number (PAN). Failure to do so shall lead to disqualification.
5. **Conditional Bids or Deviations:** Any bid containing deviations, exceptions, conditions, or assumptions from the tender terms and conditions shall be treated as non-responsive and summarily rejected.
6. **Unsatisfactory Client References:** In the event that even one reference provided by the bidder is found to be unsatisfactory, the bidder shall be disqualified. Internal references obtained from NAB or its associated centres may also be considered valid for disqualification purposes, regardless of whether they are formally submitted with the bid. **Conditional or Deviated Bids:** Any bid containing deviations, conditions, or modifications to the tender terms and conditions shall be summarily rejected.
7. **Incomplete Bid Submission:** It is a mandatory requirement that bidders submit comprehensive proposals covering all items listed in the tender. Any incomplete bid, including failure to quote for any item or component, shall be treated as non-compliant. Such bids shall be rejected without further correspondence, and the bidder shall be disqualified from the evaluation process.
8. **IP Address Duplication on GeM Portal:** The Government e-Marketplace (GeM) portal tracks and displays the IP addresses used by Buyers and Bidders/Sellers. Bids submitted from identical or shared IP addresses across different bidders/sellers shall be considered suspicious and will be automatically disqualified from further evaluation.
9. **Non Submission of duly signed and stamped ATC document including duly filled forms on letter head with signed and stamped**
10. **Non-Compliance with Minimum Eligibility Criteria:** Failure to meet or demonstrate conformance to the **“Pre-Qualification / Minimum Eligibility Criteria”** as specified in the tender document will result in outright rejection of the bid.
11. In addition to the above rejection criteria, if there is non-compliance of any of the clauses of this Tender Document, the Tenders are liable for rejection.
12. Additionally, ICAT could reject any Bid not fulfilling the essential parameters listed in the technical conditions of contract, should the supplier fail in justifying that the proposed solution is equivalent or better than the requested performance.

Chapter - 5

बोली के मूल्यांकन के मानदंड / Bid Evaluation Criteria

- The bidder shall comply with the Pre-qualification/Minimum Eligibility Criteria mentioned in “Chapter - 3”. Only bidders who qualified in the Pre-qualification/Minimum eligibility criteria are eligible for technical bid evaluation.
- The procurement shall be conducted under the Two Bid System (Technical and Financial Bids) and the mode of selection will be the Reverse Bidding option
- The technical bid will be open first on the date and time specified in the Tender Document. Only technically qualified bidders will be considered for Financial Bid Opening.
- **Determination of the Successful Bidder:** The Lowest financial bid of the technically qualified bids shall be deemed as the successful Bidder (“Successful Bidder”).
- In case, the Financial Bid offered by such Bidders are equal, then the Successful Bidder shall be determined by GeM on random basis.
- However, ICAT does not undertake to accept the lowest or indeed any bid, in all the above cases.

The Technical Bids shall be awarded points based on the following evaluation criteria:

| Evaluation Parameter | Details | Marks |
|---------------------------------|---|-----------|
| Equipment Specifications | Technical Specifications/Requirements offered against the requirements spelt out in this tender. | 55 |
| Service Support | Local Support (Delhi NCR) Within NCR - 4 Marks Outside NCR & Within India - 2 Marks | 4 |
| | Response Time (In Hours) <24 Hours - 2 Marks >24 Hours & < 48 hours - 1 Marks | 2 |
| Bidder’s Past Experience | Successfully supplied and installed same/similar machines (Refer Sr. No. 5 of Chapter 3, Eligibility Criteria) during last 3 Years before bid submission 1 Project - 4 Marks 2-4 Projects - 6 Marks More Than 4 Projects - 8 Marks | 8 |
| | Experience (Nos. of Year) 3 Years (Minimum) - 5 Marks > 3 Up To 5 Years - 6 Marks More Than 5 Years - 8 Marks | 8 |

| | | |
|----------------------------|--|------------|
| Bidder's Capability | Financial Capability | |
| | Average Annual Turnover of at least 1.2 Crores in the past 3 FY: 2022-23, 2023-24 & 2024-25 1.2 Crores (Minimum) - 5 Marks > 1.2 Crores up to 3 Crores - 8 Marks More Than 3 Crores - 10 Marks | 10 |
| | Technical Capability | |
| | Project/Work Implementation Plan | 3 |
| | Utility Matrix (To gauge the bidder's preparedness, infrastructure alignment, and ability to meet project requirements) & Equipment Footprint | 3 |
| | Team Structure (Organogram/Hierarchy Chart) | 1 |
| | ISO Certification (QMS) | 1 |
| Customer Feedback | Minimum 1 Nos - 2 Marks >1 up to 2 - 3 Marks More Than 2 - 5 Marks | 5 |
| Total Marks | | 100 |

Note:

1. The pass marks in Equipment Specifications shall be 55 points out of 55 points.
2. The minimum pass marks Overall shall be 80 points (80%) out of 100 points.
3. ICAT reserves the right to give preference to the local supplier, MSME, or start-up as per prevailing government notifications and as revised from time to time

Chapter - 6

घोषणा चेकलिस्ट / Declaration Checklist

| Parameters | Documents Required | Remarks | Documents Submitted (✓/✗) |
|--|--|---|---------------------------|
| Legal Valid Entity | Copy of the registration or incorporation certificate or relevant document | | |
| Proposal Submission Compliance and Documentation Requirements | Signed and stamped Copy of all pages of tender and supporting documents. | | |
| Legal Presence in India | Certificate of Incorporation/Registration, PAN, and GST registration | | |
| Technical Specifications/Requirements offered against the requirements spelt out in this tender | Point by Point Compliance Statement with Technical Bid. | | |
| Equipment Compliance with the relevant Test Standard | Compliance Statement Required as per list of Standards mentioned in Tender | | |
| Service Support | Local Support (Delhi NCR) Within NCR Outside NCR & Within India | | |
| Consumables/Spare Part List | List of Critical Spares/Consumable for the Complete Test Systems. | List Only/Spares as per the tender scope to be covered. | |
| Bidder's Past Experience | i). Purchase Order/Work Order. ii). In addition, ICAT may ask for corresponding Completion Certificates or Client Performance Certificates issued by the end-user. | Higher the Number of Projects, higher the marks. | |
| Bidder's Past Experience in terms of years | 3 Years Old | GST, PAN or any other relevant document etc. | |
| Bidder's Financial Capability | Audited Balance Sheet duly certified by the Chartered Accountant/Certificate from Chartered Accountant indicating the turnover for the last 3 consecutive financial years (FY 2022-23, 2023-24 & 2024-25). The contact details of CA/Statutory Auditor along with UDIN No. shall be mandatorily mentioned on | | |

| | | | |
|--|--|---|--|
| | copy of certified Balance Sheet/Certificate. | | |
| Undertaking Regarding Non-Blacklisting | Signed & Stamped Copy of Declaration as per Format in Tender/On Company Letter Head. | | |
| Compliance with Rule 144(xi) of GFR 2017 (Land Border Sharing) | Signed & Stamped Copy of Declaration as per Format in Tender/On Company Letter Head. | | |
| Compliance with DIPP Notification for Make in India | Signed & Stamped Copy of Declaration as per Format in Tender/On Company Letter Head. | | |
| MSE/Start-up Exemption Request (If applicable) for Prior Turnover/ Experience | Request letter & MSE/Startup Certificate Recognition Certificate issued by DPIIT | | |
| Bidder's Technical Capability: Project/Work Implementation Plan | Gantt Chart (Week-wise) with Major Project Milestones starting from PO Release to Work Completion Period. | | |
| Bidder's Technical Capability: Utility Matrix & Equipment Footprint | A One Pager Matrix with all Utility/IT/Civil Requirements for making the Machine/Equipment Fully Functional. Tentative GA Layout/Drawing of Complete Setup with Equipment Footprint. | | |
| Bidder's Technical Capability: Team Structure | Organogram/Hierarchy Chart/Organisation Chart (Name, Role and Years of Experience) | | |
| Bidder's Technical Capability: Technical Manpower (Team's Capability) | One Pager List of Technical Manpower who will be employed for the Project (Degree/Diploma/ITI/Helpers) and/or CVs. | More the manpower higher would be score | |
| Bidder's Technical Capability: ISO Certification | Applicable Certificate Copy | | |
| Customer Feedback | List of Past Customers (Name, Company Address, Contact Number, Email ID), Customer Feedbacks if given by Past Clients | Higher the Feedback, higher is score. | |
| Deviation Statement | Point-wise Deviation/Exceptions/Assumptions Statement (If any) from the Technical Requirement. | Only Better/Higher Specs Alternatives are acceptable at the sole discretion of the Purchaser. | |

बोली लगाने वालों के लिए निर्देश / Instructions To Bidders

1. **Submission of Quotation and Technical Documentation:** The bidder shall submit a comprehensive quotation strictly in accordance with the detailed Scope of Work and Services outlined in “Chapter - 2” of the Additional Terms and Conditions (ATC) document. The quotation must include both the technical and financial components as prescribed in the tender.
2. **Site Visit Requirement (Not Applicable) :** Bidders are strongly advised to undertake a site visit to the Purchaser’s facility in order to gain a comprehensive understanding of the existing Automation System, lab equipment, communication interfaces, and integration requirements necessary for the successful execution of the project. This visit is critical to ensure that the proposed solution is compatible with the current infrastructure and operational environment. The site visit must be scheduled and completed before the last date of bid submission. Bidders shall submit a written request to the Purchaser no later than two (2) days prior to their intended visit date to obtain necessary access and coordination. All arrangements for the visit, including travel and associated expenses, shall be the sole responsibility of the Bidder. Failure to conduct the site visit within the specified timeframe shall not be accepted as grounds for any future claim, delay, or deviation from the scope of work. The Purchaser shall bear no responsibility for any misinterpretation or assumption made by the Bidder due to the lack of a site inspection.

3. Pre-Bid Meeting Conditions

3.1 Pre-Bid Meeting shall be held to address queries and provide clarifications regarding the scope of work, technical requirements, and the bid submission process.

- Venue: ICAT
- Mode: Physical Meeting or Virtual

All interested bidders are encouraged to attend the pre-bid meeting to seek necessary clarifications before submission of their bids.

3.2 Submission of Pre-Bid Queries

Bidders are required to submit their queries, if any, in writing to manish.pandey@icat.in, amol.kumar@icat.in, prem.purang@icat.in & javed.rahi@icat.in. Bidders are required to submit their queries (if any) in writing within 2 days prior to the pre-bid meeting date.

Queries should be submitted in the following format:

| Sl. No. | Clause No. | Existing Provision | Query/Suggestion |
|---------|------------|--------------------|------------------|
|---------|------------|--------------------|------------------|

3.3 Clarifications and Amendments

- Clarifications and responses to the pre-bid queries shall be issued in the form of a Corrigendum/ Addendum and uploaded on the GeM Portal & ICAT Website.
- The corrigendum shall form an integral part of the tender document and must be duly considered while submitting the final bid.

3.4 No Individual Communication

- No individual responses will be provided to bidders. All clarifications shall be shared only through official corrigenda.

3.5 Non-Mandatory Attendance

- Attendance at the pre-bid meeting is not mandatory for bid submission. However, it is strongly recommended to attend for a complete understanding of the requirements.

3.6 Binding Clarifications Only Through Corrigendum

- Only clarifications provided through officially issued corrigenda shall be considered binding. Any verbal discussions or informal exchanges during the pre-bid meeting shall not be treated as official unless formally incorporated.

3.7 No Suggestions or Deviations Post Submission Deadline

- No suggestions, deviations, modifications, or requests for clarification shall be entertained after the bid submission deadline. Bidders are therefore advised to seek all necessary clarifications and raise concerns during the pre-bid period.

4. Submission of Bids

Bidders are required to submit their bids in two separate parts as detailed below:

- **Part I - Technical Bid:** This shall include all relevant documents and information demonstrating the bidder's compliance with the technical specifications and eligibility criteria as outlined in the tender document and Chapter - 2 & 3. **Bidders must not divulge price of tendered item in technical bid. Violation of the same may lead to rejection of the bid.**
- **Part II - Financial Bid:** This shall contain the price proposal strictly in the format prescribed in the tender document.

Both parts must be submitted in separate as specified in the e-tendering or GeM platform.

5. Evaluation Process

- Stage 1 - Technical Evaluation: The Technical Bids shall be opened and evaluated first. Only those bidders who meet all mandatory requirements and obtain the minimum qualifying marks, including full marks in technical capability (as applicable), shall be deemed technically qualified.
- Stage 2 - Financial Evaluation: The Financial Bids of only the technically qualified bidders will be opened and considered for further evaluation. Financial Bids of bidders who fail to qualify in the technical stage shall be returned unopened or disqualified from further consideration.

- 6. **Availability of Tender Documents and Corrigendum:** Prospective Bidders are advised to regularly visit the official website of the International Centre for Automotive Technology (ICAT) at www.icat.in and/or the Government e-Marketplace (GeM) portal for downloading the complete Tender Document, including all instructions, terms, specifications, and any corrigendum, amendment, clarification, or notification issued in connection with this Tender.

It shall be the sole responsibility of the Bidder to ensure that they have the latest version of the Tender Document and are fully aware of all updates, revisions, or corrigenda issued prior to the bid submission deadline. ICAT shall bear no responsibility or liability for any oversight or failure on the part of the Bidder to obtain such information from the aforementioned platforms.

Chapter 8

बयाना राशि (EMD) / Earnest Money Deposit (EMD)

Earnest Money Deposit (EMD): INR 79,680/- (Rupees Seventy Nine Thousand Six Hundred Eighty only) can be submitted in form of **DD/Bank Guarantee/ Banker's Cheque drawn in favour of "International Centre for Automotive Technology"**, payable at Manesar/ Gurugram valid for at least six months from any branch of Delhi/NCR of Indian scheduled Bank or **Online through RTGS/NEFT/Internet Banking** in Beneficiary Name **"International Centre for Automotive Technology"**.

Or

Firms who are registered with Start-ups as recognized by Department for Promotion of Industry and Internal Trade (DPIIT), holding valid Startup Recognition Certificate/ Micro and Small Enterprises (MSEs) who are holding valid Udyam Registration and are manufacturer of the offered Product or Service, shall be exempted from submission of Earnest Money Deposit (EMD), subject to the following conditions:

- A **valid registration certificate** clearly indicating coverage for the **tendered item** must be submitted along with the **Technical Bid**.
- The registration certificate should remain **valid for a minimum of six (6) months** from the **last date of bid submission**.
- Exemption shall be granted **only for procurement of goods/services** directly covered under the registration.
- **Note:** The exemption shall **not apply to traders, agents, dealers, distributors, or firms engaged in works contracts**, even if they are registered under MSE or Startup.

Or

In place of a Bid security, Bidders can submit Bid securing declaration as per approved attached form accepting that if they withdraw or modify their Bids during the period of validity, or if they are awarded the contract and they fail to sign the contract, or to submit a performance security before the deadline defined in the request for bids document, they will be suspended for the period of 1 year from the date of opening of this bid from being eligible to submit Bids for contracts with the ICAT that invited the Bid.

ICAT Bank Details for NEFT/RTGS (in case any bidder deposits the EMD of INR 79,680/- (Rupees Seventy Nine Thousand Six Hundred Eighty only) through NEFT/RTGS)

HDFC Bank Details (Saving A/c for transactions in INR Only); -

| | |
|-------------------------|--|
| Beneficiary Name | International Centre for Automotive Technology |
| Bank Name | HDFC Bank Ltd. |
| Branch | Plot-K, Sector-2, Manesar-122051 Haryana |
| Account No. | 05891450000118 |
| Account Type | Saving |
| RTGS IFSC Code | HDFC0000589 |
| Swift Code | HDFCINBB |
| MICR Code | 110240079 |

Proof of payment shall be submitted online on GeM portal & original DD/Banker's Cheque/Bank Guarantee/Pay Order should reach at **"To, The Purchase Department, International Centre For Automotive Technology, Plot No. 26, Sector - 3, Near HSIIDC Office, IMT Manesar, Gurugram - 122050 (Haryana).**

Key Note's

- EMD shall be exempted to Micro & Small Enterprises registered for the tendered items/as per the latest Govt. of India guidelines. MSME/Start-up Policy is meant for procurement of only goods produced and services rendered by MSE's. However, traders/distributors/sole agent/works contracts are excluded from the purview of Public Procurement Policy for MSEs Order, 2012. The bidders claiming the preference must submit the relevant document (The certificate should be valid for at least 6 months from the date of submission of bids).
- The bid received without EMD/Documentary proof of Exemption of EMD, will be summarily rejected.
- Cheque/Money Order/Cash shall not be accepted as EMD.
- A bid will be rejected if EMD is found to be of lesser amount or EMD is not submitted in the manner prescribed.
- A bid which is not accompanied by such Earnest Money Deposit or Non-Submission of Bid Security Declaration Form will be construed as non-compliant bid and should be rejected.
- The Earnest Money Deposit (EMD) of the unsuccessful bidder will be returned to them within 30 days after finalization and award of the tender without any interest. The Earnest Money Deposit of the successful Bidder will be returned upon the successful Bidder furnishing the Performance Bank Guarantee.

The Earnest Money Deposit (EMD) submitted by the Bidder shall be liable to be forfeited in full in favor of ICAT without any prior notice or prejudice to any other rights or remedies available to ICAT under the contract or applicable law, in the event the Bidder: -

- The EMD may be forfeited, if a Bidder withdraws/modifies his bid during the period of bid validity or on submission of false documents/undertaking.
- Without the written consent of ICAT, it has withdrawn its Bid during the validity period of the Bids and any extensions thereto.
- After opening of the financial bid, alters the quoted rates/conditions in the Bid.
- Fails to provide /furnish the **Performance Security** within stipulated period mentioned in the Letter of Acceptance.
- Does not reply to any queries that may be raised after opening of technical/financial bids.
- If the bidder does not accept the corrections made by ICAT to its Bid Price pursuant to "Examination of Financial Proposal and Correction of Arithmetical Errors".

Chapter 9

अनुबंध की विशेष शर्तें / Special Conditions of Contract

The table below provides Special Conditions of Contract for this Tender Document. The following clauses under this Special Conditions of Contract (SCC) complements to the corresponding clauses in the Tender. Whenever there is a conflict, the provisions herein shall prevail over those in the tender.

| Item | Data |
|--|--|
| Terms of Payment | As per clause 10 of Chapter 2 |
| Payment Schedule | As per clause 10 of Chapter 2 |
| Warranty Period, counted from Acceptance | 2-years onsite warranty includes of parts |
| Liquidated Damages | In the event of seller's failure to deliver the goods/equipment as per date/dates specified in the contract, ICAT may deduct from the seller as agreed, Liquidated Damages @ 0.5% of the Contract Sum of the delayed supplies for each week or part of a week for which the delay has occurred, subject to maximum of 10% of the Contract Sum. |
| Performance Bank Guarantee (PBG) | Within fifteen [15] days from the date of acceptance of the PO, the Successful Bidder shall execute a Performance Bank Guarantee (format of PBG shall be as per Form VII of this ATC), from any branch at Delhi/NCR of Indian scheduled Bank, for an amount equivalent to the 5% of the contract value to cover the delivery period as well as warranty period. The PBG shall be made in INR only. |
| Address For Recipient's Communications | Purchase Department International Centre for Automotive Technology Plot No # 26, Sector-3, HSIIDC, IMT Manesar, Gurgaon- 122050 |
| Method of Bid Evaluation | Segregated |

Chapter-10

पूर्व-स्वीकृति मानदंड / Pre-Acceptance Criteria

Acceptance Criteria:

All drawings, requirements on utilities, interfaces with Civil Works and lists of elements to be supplied, including main specifications, shall be verified and accepted by ICAT. Modifications shall be implemented on those documents by the supplier, should ICAT require too.

Pre-acceptance

Prior to delivery, ICAT representatives shall perform an extensive inspection and testing on complete assembly of the equipment to be supplied in order for the supplier to demonstrate compliance with the requirements of the tender.

Any faults or items of non-compliance with the requirements of the tender will be rectified free of charge by the contractor to the satisfaction of ICAT.

Pre-acceptance tests shall last 3 days. Completion of the offsite checks does not constitute an agreement that the equipment complies in all respects to the specification.

Pre-acceptance of Emergency Locking Retractor, Retractor Durability, Microslip/Abrasion and Bus Window Durability Test Rigs as mentioned in scope of supply.

The pre-acceptance visit will imply:

- Visual inspection of the actual equipment
- Inspection of the testing equipment when running a real sample/reaction bracket.
- Inspection of the calibration procedure.
- Verification of the equipment to certify that it allows to perform the tests according to the regulations listed in this tender and that it fulfills the real needs of the laboratory.

Chapter – 11

अंतिम स्वीकृति मानदंड / Final Acceptance Criteria

Final acceptance

First the following checks will be performed:

- Calibration certificate will be checked with the serial numbers of the equipment delivered on site. Values obtained in the calibrations will be checked to be admissible.
- A full recalibration will be done on-site.
- Validation of the sensors (bridges, connectors, identification).
- Validation of the software. The correct running of the software and data dump will also be checked.
- Connections and validation of power supply.
- Validation of systems.
- Validation of calibration plan during warranty.
- Validation of the documentation provided.
- Any of the tests included in the standards listed in this tender may be performed with the supplied equipment
- Inspections will be undertaken with different samples to prove that operation and results of the equipment fulfil the requirements demanded in this tender document.

After complete positive achievement of the above checks, the following tests will be performed.

Full check for all subsystems

Upon delivery a full system check and demonstration by the supplier shall be conducted to the satisfaction of the representative of ICAT. All auxiliary devices compliancy with the required performances needs to be demonstrated by the supplier. Interface with all Utilities and all Safety Measures shall be checked and demonstrated by the supplier. Any faults of non-compliance with the specification not found in the pre-delivery inspection will be rectified, free of charge, by the supplier.

Acceptance test for auxiliary devices

ICAT reserves the right of checking the behavior of the chiller, control system and all auxiliary devices by performing any of the tests mentioned in the technical specifications. Supplier shall demonstrate that performances and accuracy are met.

Form: I

वेंडर जानकारी फॉर्म (VIF) / Vendor information form

| | | |
|-----------|--|--|
| 1 | Name of the Bidder | |
| 2 | Address of the Bidder | |
| 3 | Contact Details of the Bidder | |
| | Telephone No. With STD Code | |
| | Fax No. | |
| | Mobile No. | |
| | E-mail ID & Website if any | |
| 4 | Nature of Business (Product/Services) | |
| 5 | Name of Proprietor/Partners/Directors of Firm/Agency | |
| 6 | Company Establishment Year | |
| 7 | Whether registered with Startup/MSE (Please enclose relevant self-attested photocopy of Certificates) | |
| 8 | Bidder Bank Details (Please attached cancelled cheque): | |
| | Name of Account Holder | |
| | Account Type (Current/Savings) | |
| | Complete A/c No. | |
| | Name of Bank | |
| | Name of the Branch with Complete Address | |
| | IFSC Code of the Branch | |
| | 9 Digit MICR Code of the Branch | |
| 9 | Legal status of the bidder such as Company, partnership/proprietorship concern, etc. | |
| 10 | GST Registration No. | |
| 11 | Permanent Income Tax Number (PAN) No. | |

(Seal of Organization & Signature of Authorized Signatory)

Date

Form: II

न्यूनतम पात्रता मानदंडों के लिए चेकलिस्ट / Checklist for minimum eligibility criteria

| Sl. No | Information Sought | Type of Proof | Page No. of the bid |
|--------|---|---------------|---------------------|
| 1. | Date of Establishment/Incorporation | | |
| 2. | Company Status (Prop. /Partnership/Pvt. Ltd. Co./Public Limited Co./PSU/Govt) | | |
| 3. | PAN No. of the firm (Enclose self-attested photocopy) | | |
| 4. | GST Registration No. (Please enclose self-attested photocopy of certificate) | | |
| 5. | Proof of Experience as per Chapter 3 | | |
| 6. | Proof of Turnover for the last three financial years 2022-23, 2023-24 & 2024-25 as per clause 7 of chapter 3. | | |
| 7. | Proof of References as per clause 6 of chapter 3. | | |
| 8. | Self-attested photocopies of Income Tax Return (I.T.R) for the last 3 years (i.e. 2022-23, 2023-24 & 2024-25) | | |
| 9. | Declarations and undertaking to be submitted as per Form IV & VIII | | |

Signature of the authorized person

Seal:

Name:

Date: Place:

Form: III

बोली लगाने वाले की ओर से स्वीकृति / Acceptance from the bidder

I have gone through the terms and conditions of the tender documents and the same acceptable to us. I have given the price bid/ tender after confirming the nature of work in ICAT, Manesar.

Place:

Signature:

Date:

Name of the Proprietor:

Seal:

Enclosures:

Copies of the documents duly signed & stamped tick marked as () hereunder, have been attached:

- () 1. ICAT's Tender Document duly signed & stamped
- () 2. Undertaking as per Form VIII.
- () 3. Declaration 1, 2, 3,4 & 5 as per Form IV.
- () 4. Copy of three years latest Income Tax Return/ Clearance Certificate.
- () 5. Financial Bid.
- () 6. Any other document which has been missed as per tender requirement. (Please Specify).

Form: IV

{Format for each of the Declarations & Undertaking to be typed on bidder's letter head separately and to be submitted in Part -I (TECHNICAL BID) of the tender document}

DECLARATION -1

This is to certify that neither we/any of us/ are/is in any way related to any employee in the International Centre for Automotive Technology (ICAT).

Dated :

Place :

(Signature of the bidder with seal/ rubber stamp)

DECLARATION -2

We hereby declare that we have not stipulated any extra condition along with the Part-II (COMMERCIAL BID) of the tender and the terms and conditions in Part I and Part II of the tender shall prevail under all circumstances.

Dated :

Place :

(Signature of the bidder with seal/ rubber stamp)

DECLARATION-3

I/We having our office as mentioned below and declare that I/we have never been blacklisted/De-registered/debarred by any Departments/Ministries of the Govt. of India or of any State Government, PSU or Any Reputed Private Organization/Institution in India, for which we have executed/undertaken the works/services during the last 3 Years

Name :

Designation :

Name of the Bidder :

Address of the Bidder :

Date :

Place :

DECLARATION-4

(Declaration regarding Make in India)

In line with Government Public Procurement Order No. P-45021/2/2017-BE-II dt. 15.06.2017 & P-45021/2/2017-PP (BE-II) dated 28.05.2018, we hereby certify that we M/s _____ (supplier name) are local supplier meeting the requirement of minimum local content (____%) as defined in above orders against Tender/Enquiry No.

Details of location at which local value addition will be made is as follows:

DECLARATION-5

(Declaration regarding compliance of Rule 144 (xi) of GFR
2017)

“I/We have read the clause regarding restrictions on procurement/sub-contracting from an entity/natural person/agent/consortium/Joint venture having beneficial ownership in countries which share land border with India. I/We certify that neither we are not from such a country nor having any beneficial ownership from such a country. If I/We from such a country or having beneficial ownership, are registered with the competent authority. I/We hereby certify that we fulfill all requirements in this regard and are eligible to be considered. [Where applicable, evidence of valid registration by the Competent Authority shall be attached.]”

Authorized Signatory

* We also understand, false declarations will be in breach of the Code of Integrity under Rule 175(1)(i)(h) of the General Financial Rules for which a bidder or its successors can be debarred for up to two years as per Rule 151 (iii) of the General Financial Rules and would be a ground for immediate termination and further legal action in accordance with law.

Form: V

अर्नेस्ट मनी डिपॉजिट (EMD) का फॉर्मेट / Format of Earnest

(To be executed on non-Judicial stamped paper of an appropriate value)

To,

The International Centre for Automotive Technology
Plot No. 26, Sector - 3,
IMT, Manesar,
Gurgaon,

Dear Sirs,

WHEREAS

(hereinafter called the "Bidder") has submitted their offer dated _____ for _____ (hereinafter called the "Bid") against the buyer's request for Tender No. _____ KNOW ALL MEN by these presents that we _____ having our registered office at _____ are bound onto International Centre for Automotive Technology having its office at Plot No. 26, Sector-3, IMT Manesar, Gurgaon-122050 (hereinafter referred to as the "Buyer") for the sum of Rs. _____ (_____) for which payment will and truly to be made to the said buyer, the bank binds itself, its successors and assigns by these presents.

The Bank hereby undertakes to pay under this guarantee, the Guaranteed Amount claimed by the Owner without any further proof or conditions and without demur, reservation, contest, recourse, or protest and without any enquiry or notification to the bidder merely on a demand from the Owner stating that the amount claimed is due to the Owner under the Contract. Any such demand made on the bank by the Owner shall be conclusive as regards the amount due and payable by the bank under this bank guarantee and the bank shall pay without any deductions or set offs or counterclaims whatsoever, the total sum claimed by the Owner in such Demand. The Owner shall have the right to make an unlimited number of demands under this bank guarantee provided that the aggregate of all sums paid to the Owner by the Bank under this bank guarantee shall not exceed the Guaranteed Amount.

The Guarantee will remain in force upto _____ after the period of tender validity and any demand in respect thereof should reach the bank not later than the above date.

Notwithstanding anything contained herein our liability under this bank guarantee shall not exceed Rs. _____ (_____). This bank guarantee shall be valid upto _____ and we are liable to pay the guaranteed amount or any part thereof under this bank guarantee only and only if you serve upon us a written claim or demand on or before _____.

All claims under this guarantee will be payable at _____

_____. This guarantee will be returned to us as soon as the purpose for which it is issued is fulfilled or its expiry whichever is earlier. If we are not in receipt of this original bank guarantee within the stipulated period, it shall be deemed to be automatically cancelled unless extended further before expiry of validity.

AND WHEREAS one of the terms of the said tender is that you shall submit an EMD of Rs. _____
/- (Rupees _____ only) to the bidder.

Now, We _____
(hereinafter referred to as 'Bank') having its registered office at _____
_____ and branch office at _____
_____ hereby irrevocably agree and undertake as follows:

1. That the said bidder shall submit the bank guarantee of Rs. _____ /- (Rupees _____ only) towards EMD.
2. That the said 'bidder' shall duly and faithfully carry out to your satisfaction its obligation under the said Tender failing which we hereby unconditionally and irrevocably guarantee to pay to you without reference to the said 'bidder' and without any demur, merely on demand from you stating that the amount claimed is due, all or any sums of monies up to a maximum of Rs. _____/- (Rupees _____ only). Any such demand made on us by you shall be conclusive as regards the amount due and payable by us under this guarantee. However, our liability under this guarantee shall be restricted to an amount not exceeding Rs. _____/- (Rupees _____ only).
3. We, the Bank, further agree that we shall accept the correctness of any claim that may be made by you without raising any objection of whatsoever nature irrespective of any dispute or difference between the 'bidder' and you and the statement so submitted by you shall be binding and conclusive on us. We hereby further unconditionally and irrevocably guarantee that the amount hereby guaranteed shall become due and payable on your serving us with a notice requiring of the said amount and the said notice shall be deemed to have been serviced on us if delivered by personal delivery or any other mode (i.e. Courier/Post/Fax/E-mail etc.) and the payment under this guarantee shall be made by us within three days from the date of receipt of such notice, without reference to 'bidder'.
4. We, the Bank, further agree that the guarantee herein contained shall remain in full force and effect during the period that will be taken against EMD or till you certify that the terms and conditions of the said Tender have been fully and properly carried out by the bidder and accordingly discharge the guarantee, whichever is earlier. Unless the demand or claim under this guarantee is made on us in writing on or before _____ shall be discharged from all liability under this guarantee thereafter.
5. We, the Bank, hereby agree that the decision of ICAT as to whether the bidder has failed to or neglected to perform or discharge his duties and obligations under the said tender shall be final and binding on the Bank.
6. We, the Bank, further agree that you shall have the fullest liberty without our consent and without affecting in any manner our obligations hereunder to vary any of the terms and conditions of the said tender which is accepted by bidder or to extend time from time to time or to postpone for any time or from time to time the powers exercisable by you against the bidder and to forebear to enforce any of the terms and conditions of the tender and we shall not be relieved from our liability for any reason of any such variation or any extension granted to the said 'bidder' or for any forbearance or omission on your part or any indulgence by you to the said 'bidder' or by any such matter or thing whatsoever which under the law relating to sureties would but for this provision have the effect of relieving us.

7. The guarantee herein shall not be determined or become ineffective by reason of the fact or winding up, liquidation, dissolution or change of constitution or insolvency of the 'bidder' and/or bank but shall remain in full force and effect and shall be binding and operative till expiry of the period hereinafter specified.
8. We, the Bank, lastly undertake not to revoke the guarantee during its currency except with the previous consent of ICAT in writing.
9. We further agree that this guarantee shall be governed by Indian Law.
10. We also agree that this guarantee is subject to the jurisdiction of the courts situated at **Gurgaon** and if any dispute arises in respect of or in connection with this guarantee, the same shall be tried only at the courts situated at **Gurgaon** and not by any other courts.
11. NOTWITHSTANDING anything contained hereinabove our liability under this guarantee is restricted to Rs. _____/- (Rupees _____ only). This guarantee shall remain valid till _____ only. Unless a claim in writing is lodged with us within 3 months from the expiry of this bank guarantee, your rights under this guarantee shall be forfeited and we shall be released and discharged from all liabilities under this guarantee.

Date:

Details of the Bank Official:

Name of the Bank Official:

Address of the Bank:

Contact No.:

Fax No.

E-mail ID:

Corporate Seal of the Bank

By its constituted Attorney Signature of a person duly authorized to sign on behalf of the Bank.

Form: VI

**EMD/बिड सिक्क्योरिटी के बदले घोषणा का प्रारूप / Format of declaration in lieu of EMD/Bid security
(To be submitted on the Bidder's Letter Head)**

Bidder's Name.....

.....
.....

(Address and Contract Details)

Bidder's Reference No.....Date.....

To,
The Director International Centre for Automotive Technology
Plot No. 26, Sector-3, Near HSIIDC, IMT Manesar Gurgaon-122050

Reference: Tender Document No.....Tender Title:.....

Sir/Madam,

We, the undersigned, solemnly declare that:

We understand that according to the conditions of this Tender Document, bids must be supported by a Bid Securing Declaration in lieu of Bid Security.

We unconditionally accept the conditions of this Bid Securing Declaration. We understand that we shall stand automatically suspended from being eligible for bidding in any tender in ICAT for 1 Year (12 Months) from the date of opening of this bid if we breach our obligations under the tender conditions if we:

1. Withdrawn/ Amend/ Impair/ Derogate, in any respect, from our bid, within the bid validity or
- 2 Being notified within the bid validity of the acceptance of our bid by the ICAT:
 - a) Refused to or failed to produce original documents for scrutiny or the required Performance Security within the stipulated time under the conditions of the Tender Document
 - b) Fail or refuse to sign the contract

We know that this bid Securing Declaration shall expire if the contract is not awarded to us,
upon:

1. Receipt by us for your notification
 - a) of cancellation of the entire tender process or rejection of all bids or

b) of the name of the successful bidder or

2. Forty-Five days after the expiration of the bid validity period or any extension to it.

(Signature with Date)

(Name and Designation)

Duly Authorized to Sign the Bid for and on behalf of (Name & Address of Bidder and Seal of Company)

Date onday of.....

Place.....

Key Notes:-

1. The Bidder have to submit EMD/Bid security for the value specified in the Bid Documents in the form of DD/NEFT/RTGS/BG.

ii. MSE registered with Udyog Aadhar / Startup Certificate Recognition Certificate issued by DPIIT, are exempted from EMD have to submit signed 'Bid Security Declaration' as per format given (refer Form VI of this ATC) on Firm/Company letter head. MSE or firms registered with the Central Purchase organizations are required to submit their registration certificates in support of their request for exemption from EMD along with Bid security Declaration. However, as per clarification issued by DC MSME vide office memorandum dated 25th March 2022, traders/Distributors/Sole agents/Work contracts are not eligible for benefits under MSME category.

iii. Non-submission of EMD as per Bid requirement or Bid Security Declaration along with supporting documents for exemption from EMD by MSE or other exempted bidders, will be treated as unresponsive and disqualified from further procurement process as per para 7.3.1(ii) of Manual for procurement of goods 2017.

Form: VII

परफॉर्मेंस बैंक गारंटी के लिए प्रोफॉर्मा / Proforma for Performance Bank Guarantee

(To be executed on non-Judicial stamped paper of an appropriate value)

WHEREAS International Centre for Automotive Technology (ICAT) having its corporate office at Plot No. - 26, Sector - 3, HSIIDC, IMT - Manesar, Gurugram - 1220050, Haryana (India) (hereinafter referred to as "**The Owner**") which expression shall unless repugnant to the context includes their legal representatives, successors and assigns) has executed a contract on [*Please insert date of execution of Contract*] ("**Contract**") with [*insert name of the Successful Bidder*](hereinafter referred to as the "**Contractor**") which expression shall unless repugnant to the context include its legal representatives, successors and permitted assigns) for the performance, execution and implementation of the Works ("**Works**" shall have the meaning ascribed to it in the Contract] based on the terms & conditions set out in the Tender Documents number [*insert reference number of the Tender Documents*] dated [*insert date of issue of Tender Documents*].....and various other documents forming part thereof.

AND WHEREAS one of the conditions of the Contract is that the Contractor shall furnish to the Owner a Bank Guarantee from a scheduled bank in India having a branch at New Delhi for an amount equal to 5% (five percent) of the total Contract Sum (the amount guaranteed under this bank guarantee shall hereinafter be referred to as the "**Guaranteed Amount**") against due and faithful performance of the Contract from the post-commissioning stage of the Works under the Contract, including the performance bank guarantee obligation and other obligations of the Contractor for the supplies made and the Works being performed and executed by under the Contract. This bank guarantee shall be valid from the date hereof up to the expiry of the Warranty Period including any extension thereof.

AND WHEREAS the Contractor has approached [*insert the name of the scheduled bank*] (here in after referred to as the "**Bank**") having its registered office at [*insert the address*].....and at the request of the Contractor and in consideration of the promises made by the Contractor, the Bank has agreed to give such guarantee as hereunder:-

- (i) The Bank hereby undertakes to pay under this guarantee, the Guaranteed Amount claimed by the Owner without any further proof or conditions and without demur, reservation, contest, recourse or protest and without any enquiry or notification to the Contractor merely on a demand from the Owner stating that the amount claimed is due to the Owner under the Contract. Any such demand made on the Bank by the Owner shall be conclusive as regards the amount due and payable by the Bank under this bank guarantee and the Bank shall pay without any deductions or set-offs or counterclaims whatsoever, the total sum claimed by the Owner in such Demand. The Owner shall have the right to make an unlimited number of Demands under this bank guarantee provided that the aggregate of all sums paid to the Owner by the Bank under this bank guarantee shall not exceed the Guaranteed Amount.
- (ii) However, the Bank's liability under this bank guarantee shall be restricted to an amount not exceeding [*figure of Guaranteed Amount to be inserted here*].....
.....only).
- (iii) The Owner will have the full liberty without reference to the Bank and without affecting the bank guarantee to postpone for any time or from time to time the exercise of any powers and rights conferred on the Owner under the Contract and to enforce or to forbear endorsing any powers or rights or by

reasons of time being given to the Contractor which under law relating the Surety would but for the provisions have the effect of releasing the surety.

- (iv) The rights of the Owner to recover the Guaranteed Amount from the Bank in the manner aforesaid will not be affected or suspended by reasons of the fact that any dispute or disputes have been raised by the Contractor and / or that any dispute(s) are pending before any office, tribunal or court in respect of such Guaranteed Amount and/ or the Contract.
- (v) The guarantee herein contained shall not be affected by the liquidation or winding up, dissolution, change of constitution or insolvency of the Contractor but shall in all respects and for all purposes be binding and operative until payment of all money due to the Owner in respect of such liability or liabilities is affected.
- (vi) This bank guarantee shall be governed by and construed in accordance with the laws of the Republic of India and the parties to this bank guarantee hereby submit to the jurisdiction of the Courts of New Delhi for the purposes of settling any disputes or differences which may arise out of or in connection with this bank guarantee and for the purposes of enforcement under this bank guarantee.
- (vii) All capitalized words used but not defined herein shall have the meanings assigned to them under the Contract.

NOTWITHSTANDING anything stated above, the liability of the Bank under this bank guarantee is restricted to the Guaranteed Amount and this bank guarantee shall expire on the expiry of the Warranty Period under the Contract. Unless a Demand under this bank guarantee is filed against the Bank within six (6) months from the date of expiry of this bank guarantee all the rights of the Owner under this bank guarantee shall be forfeited and the Bank shall be relieved and discharged from all liabilities hereunder. However, if the Contractor's obligations against which this bank guarantee is given, are not completed, or fully performed by the Contractor within the period prescribed under the Contract, the Bank hereby agrees to further extend the bank guarantee for further periods of six months each till the Contractor fulfills its obligations under the Contract.

We have the power to issue this bank guarantee in your favor under Memorandum and Article of Association and the Undersigned has full power to do so under the Power of Attorney dated [*date of power of attorney to be inserted*]granted to him by the Bank.

Date:

Details of the Bank Official:

Name of the Bank Official:

Address of the Bank:

Contact No.:

Fax No.

E-mail ID:

Corporate Seal of the Bank

By its constituted Attorney Signature of a person duly authorized to sign on behalf of the Bank

Form: VIII

उपक्रम / Undertaking

This is to certify that we have carefully gone through the scope of work, job requirement, terms and conditions given in the tender documents & have clearly understood the terms & conditions of the tender and have accordingly quoted our balanced rates after going through all details. We hereby give an undertaking that we shall the material & services in accordance with your Tender No. _____, dated _____ as per the requirement during the period of contract.

Dated :

Place :

(Signature of the bidder with seal/ rubber stamp)

Form: IX

प्रमुख अनुबंधों का विवरण / Details of major contracts

Details of major contracts with Central Government, State Governments, PSUs/ Nationalized Banks/ Reputed Private Firms handled by the Bidder for **Upgradation of Controller and Software of Test Machines (Emergency Locking Retractor, Retractor Durability, Microslip/Abrasion and Bus Window Durability Test Rigs.)** during the last three (3) years in the following format (attested copies of the PO's and completion certificates may be enclosed).

| Sr. No | Details of client along with address, contact details (telephone, email, website, fax etc) | No. of projects executed | Amount of contract (Rs. lakh per year) | Duration of contract | |
|--------|--|--------------------------|--|----------------------|----------------------|
| | | | | Order received date | Date of Supply & I&C |
| 1. | | | | | |
| 2. | | | | | |
| 3. | | | | | |
| 4. | | | | | |
| 5. | | | | | |

Form: X

सुझाए गए बदलाव / Deviations Suggested

[The Bidder must declare and justify here any modification or improvement to the Conditions of Contract proposed to in the interest of ICAT. Such suggestions should be concise and to the point. In case, the Bidder does not want to suggest any deviation, this section must contain a statement indicating "No Deviation Suggested"]

[The Bidder shall use the following template in order to explain the deviations, and fill and include in the current document as many templates as deviations appear in his offer with regards to Requirements expressed in this tender. The Bidder shall be required to furnish a separate sheet as per the following template for each deviation suggested.]

| | |
|---|---|
| Requirement ID (as specified in the Form II - Checklist): | <i>[Requirement ID (or range of IDs) this deviation is referring to on the checklist]</i> |
| Subject | Minimum Requirement appearing on the Checklist and TCC |
| | <i>[Please copy the requirement on the TCC or Checklist form II]</i> |
| Proposed Specification | |
| <i>[Explain in detail what alternative solution are you proposing]</i> | |
| Reasons for the proposed solution to be superior than initial requirement | |
| <i>[Give clear reasons why you think the proposed solution is better than the Requirement expressed in TCC and Checklist]</i> | |

Form: XI

हितों के टकराव के संबंध में घोषणा / Declaration in Respect of Conflict of Interest

Tender No. ICAT/GeM/CTL/Upgradation-C&S/2026-27/86

Tender for “Upgradation of Controller and Software of Test Machines (Emergency Locking Retractor, Retractor Durability, Microslip/Abrasion and Bus Window Durability Test Rigs.) in Component Test Lab (CTL) at ICAT Centre- I, Manesar, Haryana”.

| Sr. No. | Particulars | |
|---------|--|--|
| 1 | Name of Firm | |
| 2 | Office Address Phone No. Fax No. Email ID | |
| 3 | Works Address as per Vendor Registration Phone No. Fax No. Email ID | |
| 4 | Type of Firm | Private Limited Company / Public Limited Company / Limited Liability Partnership (LLP) / Partnership Firm / Proprietor Firm <i>(Tick whichever is applicable)</i> |
| 5 | CIN / LLPIN of Firm | |
| 6 | GST No. of Firm | |
| | Names of all Directors/LLP Partners/ Partners / Proprietors of Bidder Firm with DIN (if any) and full address (as on the bid submission date) | |

| 7 | Sr. No. | Full Name | DIN | Full Residential Address |
|---|---------|-----------|-----|--------------------------|
| | 1 | | | |
| | 2 | | | |
| | 3 | | | |
| | 4 | | | |
| | 5 | | | |

The details of Legal Representative / Agent of the Bidder Firm are as under:

| | |
|---|--|
| Full Name of Legal Representative / Agent | |
| Whether an employee of Bidder-Firm or not? (Yes/No) | |
| Designation | |
| Office Address | |
| Office Land-Line Nos. | |
| Mobile No. | |
| Email ID | |
| Whether acting as Legal Representative / Agent in any other Private Limited Company or Public Limited Company or Limited Liability Partnership (LLP) or Partnership Firm or | |

| | |
|---|--|
| Proprietor Firm? If yes, give names. | |
|---|--|

WE HEREBY DECLARE AND CONFIRM THAT no bid has been submitted for the quoted item by any other Private Limited Company or Public Limited Company or Limited Liability Partnership (LLP) or Partnership Firm or Proprietor Firm in which any relative of any Director or Partner or Proprietor of Bidder Firm is a Director, Partner or Proprietor. The word “relative” is defined as under:

The Companies Act, 2013 Sec 2(77) “relative”, with reference to any person, means anyone who is related to another, if–

- (1) they are members of a Hindu Undivided Family.*
- (2) they are husband and wife; or*
- (3) A person shall be deemed to be the relative of another, if he or she is related to another in the following manner, namely: -*
 - a. Father including step-father,*
 - b. Mother including step-mother,*
 - c. Son including step-son,*
 - d. Son’s wife,*
 - e. Daughter,*
 - f. Daughter’s husband,*
 - g. Brother including step-brother,*
 - h. Sister including step-sister.*

WE FURTHER DECLARE THAT we have carefully read and understood the clause relating to ‘Conflict of Interest’ of Tender No. __. The detailed Clause is as under:

“A bidder shall not have conflict of interest with other bidders for quoted item. Such conflict of interest can lead to anti-competitive practices to the detriment of Procuring Entity’s interests. The bidder found to have a conflict of interest shall be disqualified. A bidder may be considered to have a conflict of interest with one or more parties in this bidding process for quoted item, if:

- a) they have proprietor/ partner(s)/ Director(s) in common; or*

- b) *they receive or have received any direct or indirect subsidy/ financial stake from any of them;*
or
- c) *they have the same legal representative/ agent for purposes of this bid; or*
- d) *they have relationship with each other, directly or through common third parties, that puts them in a position to have access to information about or influence on the bid of another bidder; or*
- e) *The bidder participates in more than one bid in this bidding process. Participation by a bidder on more than one Bid will result in the disqualification of all bids in which the parties are involved. However, this does not limit the inclusion of the components/ sub-assemblies/ assemblies from one bidding manufacturer in more than one bid.*
- f) *in cases of agents quoting in offshore procurements, on behalf of their principal manufacturers, one agent cannot represent two manufacturers or quote on their behalf in a particular tender enquiry. One manufacturer can also authorize only one agent/ dealer. There can be only one bid from the following:*
 - 1. *The principal manufacturer directly or through one Indian agent on his behalf; and*
 - 2. *Indian/ foreign agent on behalf of only one principal.*
- g) *a Bidder or any of its affiliates participated as a consultant in the preparation of the design or technical specifications of the contract that is the subject of the Bid.*
- h) *In the case of a holding company having more than one independently manufacturing unit or more than one unit having common business ownership / management, only one unit should quote. Similar restrictions would apply to closely related sister companies. Bidders must proactively declare such sister/ common business/ management units in same/ similar line of business.*
- i) *Bidder shall not act in contravention/ violation to the provisions of competition act, as amended from time to time."*

We hereby certify that our Firm M/s. _____ do not have any conflict of interest with other bidders for this tender.

We hereby declare and confirm that the above information and particulars are true and correct.

For (Firm Name)

Signature of Director/Partner/Proprietor/ Authorized Signatory

Authorized Signatory Name:

Place:

Date:

Stamp / Seal of Firm

Form: XII

प्रोडक्ट सपोर्ट घोषणा / Product Support Declaration

(To be submitted on Bidder Letter Head)

Letter No. _____

Date: _____

To,

The Purchase Officer

International Centre for Automotive Technology

Plot No. 26, Sector - 3, Near HSIIDC Office, IMT Manesar, Gurugram 122050 (Haryana)

Sub: OEM Declaration

Dear Sir,

Ref: Your ATC Reference No: ICAT/GeM/CTL/Upgradation-C&S/2026-27/86

[Bidder's Company Name] hereby submits this declaration in response to the request for clarification regarding the products quoted in our tender submission for "Tender No. ICAT/GeM/CTL/Upgradation-C&S/2026-27/86, Upgradation of Controller and Software of Test Machines (Emergency Locking Retractor, Retractor Durability, Microslip/Abrasion and Bus Window Durability Test Rigs.) in Component Test Lab (CTL) (As per detailed technical requirement given in ATC Document) at ICAT Centre I, Manesar (Haryana)."

We affirm that all products included in our bid are **not** classified as end-of-life (EOL) or obsolete as of the date of delivery. If such parts are found End-Of-Life until delivery, then it will be our responsibility to replace with newer and higher compatible parts along with implementation at no cost to the International Centre For Automotive Technology (ICAT). These products will remain available and supported for a minimum period of 10 years from the date of final acceptance, with continuous availability of spare parts, software updates, and technical support, as provided by the respective manufacturers.

Should you require any additional documentation, clarifications, or further information pertaining to the support and lifespan of the quoted products, we are prepared to provide such details upon request.

We appreciate your consideration of our submission and look forward to the possibility of further collaboration on this project.

For M/s _____

Signature & company seal

Name Designation

Email

Mobile No.

Form "XIII"

निर्माता का प्राधिकरण फॉर्म (MAF) / Manufacturer's Authorization Form (MAF)

(To be submitted Original on OEM Letter Head)

MAF No.

Dated:

To,
The Purchase Office,
International Centre For Automotive Technology
Plot No. 26, Sector - 3, Near HSIIDC, IMT Manesar, Gurgaon 122050 (Haryana)

Sub: Manufacture's Authorization Form (MAF)

Dear Sir/Ma'am,

Tender Reference No. ICAT/GeM/CTL/Upgradation-C&S/2026-27/86

We _____ who are established and reputable manufactures of _____ having factories at _____ and _____ do hereby authorize M/s _____ (Name and address of Agent/Dealer) to offer their quotation, negotiate and conclude the contract with you against the above invitation for tender offer for our _____ model.

We hereby extend our full guarantee and warranty as per terms and conditions of the tender and the contract for the equipment and services offered against this invitation for tender offer by the above firm. In case of M/s _____ is out of service due to any reason, we will make alternative arrangements for the service and maintenance of our product on same terms and condition.

Yours faithfully,

(Name)

For and on behalf of M/s _____ (Name of Manufacturer's)

Note: This letter of authority should be on the letterhead of the manufacturing concern and should be signed by a competent person of the manufacturer

Form "XIV"

बोली लगाने वाले की ओर से घोषणा और वचन-पत्र / Declaration and Undertaking from Bidder

Date: _____

To,

The Purchase Office,
International Centre For Automotive Technology
Plot No. 26, Sector - 3, Near HSIIDC, IMT Manesar, Gurugram 122050 (Haryana)

Sub: Undertaking by Original Equipment Manufacturer or Bidder against **Tender No. ICAT/GeM/CTL/Upgradation-C&S/2026-27/86 for "Upgradation of Controller and Software of Test Machines (Emergency Locking Retractor, Retractor Durability, Microslip/Abrasion and Bus Window Durability Test Rigs.) in Component Test Lab (CTL) at ICAT Centre- I, Manesar, Haryana"**.

Dear Sir/Madam,

I/We, M/s _____ (Name of the Bidder), having our registered office at _____ (address of the manufacturer), by virtue of being the original equipment manufacturer/supplier for the _____ (Name of the product(s)), Hereby provide the following confirmation:

The Product supplied by us are certified and fully compatible with the offered solution. The Product's supplied and available are not classified as End-of-Life (EOL) or End-of-Sale (EOS) for a period of 10 years from the date of final acceptance. If any part is found to be End-of- Life after acceptance, we undertake full responsibility to replace the part(s) with newer, fully compatible components and to implement the replacement at no additional cost to the International Centre for Automotive Technology (ICAT) during the warranty period of (1) Year (12 Months).

The undersigned is duly authorized to issue this undertaking on behalf of M/s _____ (Name of the Bidder).

For M/s _____ (Name of the Bidder)

Signature & Company Seal

Name:

Designation:

Email: Mobile

No.:

Form "XV"
कोई विचलन न होने का घोषणा-पत्र / No Deviation

Date: _____

To,

The Purchase Office,
International Centre for Automotive Technology
Plot No. 26, Sector - 3, Near HSIIDC, IMT Manesar, Gurgaon 122050 (Haryana)

Sub: No Deviation Declaration Dear

Sir/ Madam,

This is to certify that, the product (s) quoted items by our firm M/s.....
..... is as per the given technical specifications in the tender document & there is no deviation in relation to any conditions / requirements specified in the tender document. It is also to declare that all other commercial clauses stipulated in the tender have been carefully seen. I hereby convey the unconditional acceptance of the same.

Signature of Authorized Signatory with Stamp

For M/s _____

Signature & company seal Name

Designation

Email Mobile

No.

Form "XVI"
प्रोडक्ट अनुपालन के लिए वचन-पत्र / Undertaking for Product Compliance

(To be submitted Original on Bidder Letter Head)

To,

The Purchase Office,
International Centre for Automotive Technology
Plot No. 26, Sector - 3, Near HSIIDC, IMT Manesar, Gurgaon 122050 (Haryana)

Sub: Undertaking for Product Compliance

Dear Sir/Madam,

I/We, [Bidder/Seller's Name], hereby undertake that all the products offered in response to the tender fully comply with the specifications mentioned in the tender document. We confirm that the offered products meet the technical requirements, standards, and features outlined in the tender. In case of any deviations, we commit to notifying the buyer and obtaining approval before the delivery of products.

Date: _____

Signature of Authorized Signatory: _____

Name and Designation: _____

Seal: _____

Form XVII

उत्पाद के लिए वचन-पत्र / Undertaking for Non Subcontracting
(To be submitted Original on Bidder Letter Head)

To,

The Purchase Office,
International Centre for Automotive Technology
Plot No. 26, Sector - 3, Near HSIIDC, IMT Manesar, Gurgaon 122050 (Haryana)

Sub: Undertaking for non-subcontracting

Dear Sir/Ma'am,

I/We, [Bidder/Seller's Name], hereby undertake not to subcontract any aspect of the contract, including the supply and acceptance, without obtaining prior written consent from the buyer. We understand that failure to seek approval for subcontracting may result in disqualification from the bidding process.

Date: _____

Signature of Authorized Signatory: _____

Name and Designation: _____

Seal: _____

Form XVIII

**कीमत की उचितता का घोषणा पत्र / Price Reasonability Declaration Letter
(On Bidder Letter Head)**

To

The Director,

International Centre for Automotive Technology (ICAT),

Unit - National Automotive Board (NAB), Ministry of Heavy Industries, Government of India,

Plot No. 26, Sector 3, IMT Manesar, Gurugram - 122050, Haryana (India).

Subject: Upgradation of Controller and Software of Test Machines (Emergency Locking Retractor, Retractor Durability, Microslip/Abrasion and Bus Window Durability Test Rigs.) in Component Test Lab (CTL) at ICAT Centre- I, Manesar, Haryana

Dear Sir/Madam,

We, M/s _____ (Name of Bidder), having our registered office at _____, do hereby certify and declare as under:

1. That the prices/rates quoted by us in response to the above-mentioned tender for the Upgradation of Controller and Software of Test Machines (Emergency Locking Retractor, Retractor Durability, Microslip/Abrasion and Bus Window Durability Test Rigs.) in Component Test Lab (CTL) at ICAT Centre- I, Manesar, Haryana are exclusive to the International Centre for Automotive Technology (ICAT).
2. That the prices offered are **not higher than those charged** to any other Government Department, Public Sector Undertaking (PSU), Autonomous Body, or reputed private automotive testing agency for similar goods or services, in the **recent past**.
3. That we have extended the **maximum applicable discount** to ICAT and hereby confirm that the price quoted to ICAT is the **lowest** offered by us to any of the institutions or organizations as mentioned above for comparable goods/services.
4. That in the event it is discovered at any stage during the currency of the contract that we have supplied the same or substantially similar goods/services to any other Government/PSU/Autonomous Body/Private Automotive Testing Agency at a **lower price**, we agree and undertake that ICAT shall, at its sole discretion, be entitled to exercise any one or more of the following remedies, without prejudice to its other legal rights or remedies:
 - Demand and recover the differential amount from us by way of refund or adjustment.
 - Cancel the purchase order in full or in part, without any liability on the part of ICAT.
 - Debar/blacklist us from participation in future tenders or procurement processes of ICAT.
 - Initiate appropriate legal proceedings under applicable laws for misrepresentation or breach of declaration.

We understand and accept that this declaration is a binding commitment forming an integral part of our bid, and any violation may result in appropriate penal or legal action.

Thanking you,

Yours faithfully,

For and on behalf of M/s _____

Authorized Signatory: _____

Name & Designation: _____

Seal of the Bidder: _____

Date & Place: _____

| Form XIX चेकलिस्ट फॉर्म / Checklist Form | | | Supplier Name: | | | |
|--|---------------------------------------|--|---|---------------------|---------------------|---|
| Requirement ID | General Functionality | Specific Functionality | Requested Info for each requirement to be filled in column "Proposed Specification" | Essential parameter | Minimum Requirement | Proposed Specifications · Bidder to fill with Proposed Specification included in its Offer for each individual requirement. · Detailed description of all Items to be included in "Chapter 2: Detailed Technical Specifications". · For each Proposed Specification that deviates from Minimum Requirement, one entry shall be done in document "Form X: Deviations" |
| 1 | Reference Standards (With Amendments) | IS 15140:2018, ECE R16 & AIS 068: 2005 with Amendment No. 1 2009. | Specify Yes/No | YES | Required | |
| 2 | Bus Window Durability Test Rig | Test Standard: AIS 068: 2005 with Amendment No. 1 2009. Force: 100 N. | Specify Yes/No | YES | Required | |
| | | Stroke: 300 ± 20 mm. | Specify Yes/No | YES | Required | |
| | | Actuation frequency: 0.5 - 2 Hz | Specify Yes/No | YES | Required | |
| 3 | Emergency Locking Retractor Test Rig | Test Standard: IS 15140:2018 & ECE R16. Actuator: 1500 N (2 Nos.) Accelerometer capable of developing an acceleration increase of 25 to 150 g/s (Model No. 1201F-0050-10-240X, Sr. No. A005454) | Specify Yes/No | YES | Required | |

| | | | | | | |
|---|--------------------------------|--|----------------|-----|----------|--|
| | | Angle Mark: 12 Deg., 27 Deg., & 40 Deg. Test rig should be able to measure the displacement of webbing at defined g-value. | | | | |
| | | Servo-Controlled Acceleration & Displacement measurement & Rotary servo mechanism for angular control. | Specify Yes/No | YES | Required | |
| 4 | Microslip/Abrasion Test Rig | Test Standard: IS 15140:2018 & ECE R16. Weights: 250 N, 200 N & 50 N | Specify Yes/No | YES | Required | |
| 5 | Retractor Durability Test Rig. | Test Standard: IS 15140:2018 & ECE R16. Fast actuation for snatches. Actuation frequency: 0.5 – 2 Hz. | Specify Yes/No | YES | Required | |
| | | Individual controller (HMI) & software for all four machines and their software to be installed in one PC for data logging so that no machine will depend on others. | Specify Yes/No | YES | Required | |
| 6 | Scope of Work | A) Bus Window Durability Test Rig: Major Items Required as below: 1. HMI (Screen size – min. 10 inch) Controller with PLC & software – 1 No. 2. Any mounting to support hardware – 1 Set 3. Load Cell of 600 N. 4. All electrical, communication & any other cables etc. 5. Tower light with buzzer. 6. Electrical Panel | Specify Yes/No | YES | Required | |

| | | | | | | |
|--|--|---|--|--|--|--|
| | | <p>Any other item except above in order to run the equipment, is the responsibility of supplier.</p> | | | | |
| | | <p>B) Automation of Emergency Locking Retractor Test rig: Currently, desired g level is being achieved after trail & error method with adjusting the pressure manually and measurement of strap movement is being done manually. Need to modify the software as well as hardware (if required) so that desired g level & strap movement will be achieved automatically through servo control.</p> <p>Major Items Required as below:</p> <ol style="list-style-type: none"> 1. Servo system (For g measurement) – 1 No. 2. Servo system (For strap movement) – 1 No. 3. HMI (Screen size – min. 10 inch) Controller with PLC & software – 1 No. 4. LVDT – 1 No. 5. Load Cell with controller – 1 No. 6. Any mounting to support hardware – 1 Set 7. Servo Motor for Rotary movement of Safety Belt Assembly. 8. All electrical, communication & any other cables etc. 9. Tower light with buzzer. 10. Electrical Panel <p>Any other item except above in order to run the equipment, is the responsibility of supplier.</p> | | | | |

| | | | | | | |
|--|--|---|--|--|--|--|
| | | <p>C) Microslip/Abrasion Test Rig:</p> <p>Major Items Required as below:</p> <ol style="list-style-type: none"> 1. HMI (Screen size – min. 10 inch) Controller with PLC & Software – 1 No. 2. Any mounting to support hardware – 1 Set 3. All electrical, communication & any other cables etc. 4. Tower light with buzzer. 5. Electrical Panel <p>Any other item except above in order to run the equipment, is the responsibility of supplier.</p> | | | | |
| | | <p>D) Retractor Durability Test Rig:</p> <p>Major Items Required as below:</p> <ol style="list-style-type: none"> 1. HMI (Screen size – min. 10 inch) Controller with PLC & Software – 1 No. 2. Servo system with mountings – 1 Set. 3. Any mounting to support hardware – 1 Set 4. All electrical, communication & any other cables etc. 5. Tower light with buzzer. 6. Electrical Panel <p>Any other item except above in order to run the equipment, is the responsibility of supplier.</p> | | | | |



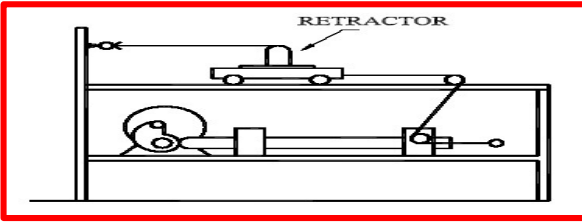

| | | | | | | |
|---|--|---|----------------|-----|----------|--|
| | | <p>E) Industrial PC (latest) compatible for Software & data storage along-with color printer:</p> <p>Any other item except above in order to run the equipment, is the responsibility of supplier.</p> | | | | |
| 7 | Brief Description of Testing method (Refer Figure - I for photographs of existing machines). | <p><u>Life cycle test for bus windows:</u></p> <p>The window shall withstand 7,000 open close cycles at a force between 50 and 75 N. with a performance degradation not exceeding 15%.</p> | Specify Yes/No | YES | Required | |
| | | <p><u>Emergency locking for safety belt retractors:</u></p> <p>A specific machine shall be included for this test.</p> <p>The following description is done in the standard. Any other option that allows the tests to be performed as per the standard's requirements shall also be accepted:</p> <p>A suitable apparatus is illustrated in the figure and consists of a motor-driven cam, the follower of which is attached by wires to a small trolley mounted on a track. The cam design and motor speed combination shall ensure that the required acceleration is given before the webbing is withdrawn out of the retractor by more than 5 mm and that the withdrawal takes place at an average rate of increase of acceleration of at least 25 g/s and not more than 150 g/s and the stroke is arranged to be in excess of the maximum</p> | Specify Yes/No | YES | Required | |

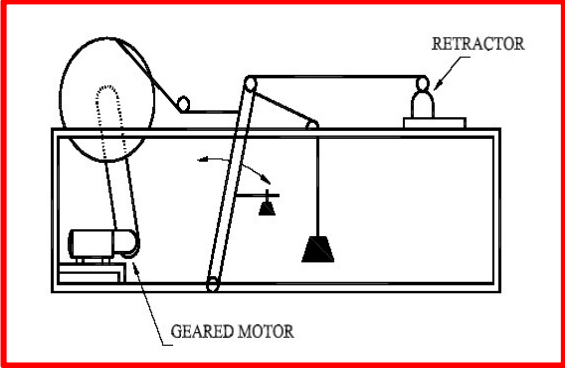
| | | | | | | |
|--|--|--|-------------------|-----|----------|--|
| | | permitted webbing movement before locking. | | | | |
| | | <p>The seat belt retractors should not block under around 0.75gs and block over 2gs When testing retractors for sensitivity to strap movement the retractor is mounted on a suitable fixed bracket and the strap is attached to the trolley.</p>  | Specify Yes/No | YES | Required | |

| | | | | | | |
|--|--|--|----------------|-----|----------|--|
| | | <p><u>Micro slip test for safety belt straps:</u></p> <p>The strap shall be subjected to a load of 50 N. at one end. At the other end, the strap shall be pulled and released back and forth with 300 mm ± 20 mm. of amplitude in a 2 Hz. cyclic movement. The load shall only be applied for 100 ± 20 mm. Therefore, the ballast shall touch the ground after 100 ± 20 mm.</p> | Specify Yes/No | YES | Required | |
| | | <p><u>Durability test for retractors of safety belts:</u></p> <p>The following description is as per standard.</p> <p>Durability of retractor mechanism</p> <p>The strap shall be withdrawn and allowed to retract for the required number of cycles at a rate of not more than 30 cycles per minute. In the case of emergency locking retractors, a snatch to lock the retractor shall be introduced at each fifth cycle.</p> | Specify Yes/No | YES | Required | |

| | | | | | | |
|----|------------------------------|---|-------------------|-----|--------------|--|
| | | <p>The snatches shall occur in equal numbers at each of five different extractions, namely, 90, 80, 75, 70 and 65 per cent of the total length of the strap remaining wound on the retractor. However, where more than 900 mm is provided the above percentages shall be related to the final 900 mm of strap which can be withdrawn from the retractor.</p> <p>A suitable apparatus for the tests specified in paragraph above is shown below.</p>  | Specify Yes/No | YES | Require d | |
| 8. | Installation & Commissioning | <p>The supplier shall install the software & hardware (If required) in above mentioned Test Rigs at ICAT Manesar. Also, the supplier shall demonstrate the working of Software with Trials in order to complete the Commissioning Process.</p> | Specify Yes/No | YES | Require d | |

| | | | | | | |
|-----|---|--|----------------|-----|----------|--|
| 9. | List of Documents/Calibration Certificates Required | The supplier shall submit the following documents: - ❖ Operation Manual of Rig [02 Hard Copies] | Specify Yes/No | YES | Required | |
| | | ❖ Technical Manual with all mechanical drawings & electrical circuit diagram [02 Hard Copies] | Specify Yes/No | YES | Required | |
| | | ❖ Software CDs (1 Nos.) | Specify Yes/No | YES | Required | |
| | | ❖ The manual, drawings & Circuits on a CD [Optional] | Specify Yes/No | YES | Required | |
| | | ❖ Calibration Certificates (Traceable to NPL/NABL Accredited Lab). | Specify Yes/No | YES | Required | |
| 10. | Warranty | The supplier shall provide the warranty for 2 years min. from Acceptance of Software. | Specify Yes/No | YES | Required | |
| 11. | Technical Support/ After Sales Services | The supplier shall provide technical support in case of any fault/breakdown of software. Also, after the expiration of warranty period the supplier must be capable to handling Comprehensive AMC for complete software. | Specify Yes/No | YES | Required | |
| | | <u>Figure I (Photographs)</u> | | | | |

| | | | | | | | |
|----|--------------------------|---|--|---------|-----|----------|--|
| | |  |  | | | | |
| | | Emergency Locking Retractor Test Rig | Bus Window Durability Test Rig | | | | |
| | |  |  | | | | |
| | | Microslip/Abrasion Test Rig | Retractor Durability Test Rig | | | | |
| 12 | Service Support | Local Support (Delhi NCR) Within NCR Outside NCR & within India | | Specify | YES | Required | |
| | | Response time (24 Hours) Within 24 hours | | Specify | YES | Required | |
| 13 | Bidder's Past Experience | Successfully supplied and installed same/similar machines (Refer Sr. No. 2 of Chapter 3, Eligibility Criteria) during last 3 Years before bid submission 1-3 projects More than 3 projects | | Specify | YES | Required | |

| | | | | | | |
|----|---------------------|---|---------|-----|----------|--|
| | | Experience (Nos. of Year) 3 years (min.) > 3 up to 5 years More than 5 years- | Specify | YES | Required | |
| 14 | Bidder's Capability | Financial Capability | | | | |
| | | Average Annual Turnover of at least 1.2 Crores in the past 3 FY: 2022-23, 2023-24 & 2024-25 1.2 Crores (min.)- > 1.2 Crores up to 3 Crores More than 3 Crores- | Specify | YES | Required | |
| | | Technical Capability | | | | |
| | | Project/Work Implementation Plan (Week-wise) | Specify | YES | Required | |
| | | Utility Matrix (To gauge the bidder's preparedness, infrastructure alignment, and ability to meet project requirements) & Equipment Footprint | Specify | YES | Required | |
| | | Team Structure (Organogram/Hierarchy Chart) | Specify | YES | Required | |
| | | Technical Manpower (Team's Capability) | Specify | YES | Required | |
| | | ISO Certification (QMS) | Specify | YES | Required | |