

Amendment No. 5 (05/2025)

To

AIS-028 (Rev 1) (Part A) Code of Practice for use of Gaseous Fuels in Internal Combustion Engine Vehicle

1.0 Clause 7.2.5

Substitute following text for existing text

A BCF fire extinguisher and dry powder fire extinguisher to meet IS: 15683 and each of 2 kg shall be kept ready within a safe distance. If ignition occurs the service valve should be closed and the extinguisher(s) used to quell any fire, which may continue.

2.0 Appendix C-1,

Delete following text

A label shall be placed adjacent to the CNG fill receptacle stating the fuelling requirements. The fuelling requirements shall be as recommended in this standard.

3.0 Appendix C-2,

Delete following text

A label shall be placed adjacent to the DIESEL+CNG fill receptacle stating the fuelling requirements. The fuelling requirements shall be as recommended in this standard.

4.0 Appendix C-3,

Delete following text

A label shall be placed adjacent to the BIOCNG fill receptacle stating the fuelling requirements. The fuelling requirements shall be as recommended in this standard.

5.0 Appendix C-4,

Delete following text

A label shall be placed adjacent to the LNG fill receptacle stating the fuelling requirements. The fuelling requirements shall be as recommended in this standard.

6.0 Appendix C-5,

Delete following text

A label shall be placed adjacent to the HCNG fill receptacle stating the fuelling requirements. The fuelling requirements shall be as recommended in this standard.

PRINTED BY
THE AUTOMOTIVE RESEARCH ASSOCIATION OF INDIA
P. B. NO. 832, PUNE 411 004

ON BEHALF OF
AUTOMOTIVE INDUSTRY STANDARDS COMMITTEE

UNDER
CENTRAL MOTOR VEHICLE RULES - TECHNICAL STANDING COMMITTEE

SET-UP BY
MINISTRY OF ROAD TRANSPORT & HIGHWAYS
GOVERNMENT OF INDIA

7th May 2025

AMENDMENT No. 4 (12/2023)

To

AIS-024 (Rev 1) (Part A)

Safety and Procedural Requirements for Type Approval of Gaseous Fuelled Vehicles

- 1.0** Substitute word “CNG/Bio-CNG/LNG/HCNG” for words “CNG/Bio-CNG/LNG” wherever it appears in the documents.
- 2.0** Substitute word “CNG/Bio-CNG/HCNG” for words “CNG/Bio-CNG” wherever it appears in the documents.
- 3.0** Substitute word “Diesel+CNG/Bio-CNG/HCNG” for words “Diesel +CNG/Bio-CNG” wherever it appears in the documents.
- 4.0** Annexure IV

Substitute following Annexure IV for existing Annexure IV

Annexure IV

SAFETY CHECKS FOR USE OF GASEOUS FUELLED (DEDICATED / BIFUEL / DUAL FUEL / DEDICATED DUAL FUEL AS APPLICABLE) INTERNAL COMBUSTION ENGINE VEHICLES (AS PER AIS-028 (REV.1) (PART A)) & INDIAN GAS CYLINDER RULES 2016 (AS AMENDED FROM TIME TO TIME)

Sr. No.	Gas Kit Component	Certifying /Verifying Authority	Clause of AIS-028 (Rev. 1) (Part A) /Other Rules, Standards, etc.
1	Gas Cylinder*	PESO, Nagpur to certify or endorse in case of foreign make	Gas cylinder rules 2016 as amended from time to time or as endorsed by PESO
1.1	Fitment of cylinder on vehicle	Test agency to verify as per AIS-028 (Rev.1) (Part A)	Clause no. 2.3, 2.5 and 2.6 of AIS-028 (Rev. 1)(Part A)
2	Gas Cylinder valves/Shut off valve *	PESO, Nagpur to certify or endorse in case of foreign make	IS: 3224 (for CNG/Bio CNG), UN R110 (for LNG valves), IS/ISO 12619 for HCNG or Gas cylinder rules 2016 or as endorsed by PESO

3	Regulator (For CNG & BIO-CNG/HCNG)/ Regulator and Vaporizer (LNG)*	Testing of the component as per IS: 15713 or ISO-15500 by test agency. Alternatively, test agency to verify the test certificate or report conforming to the above standard issued by accredited testing laboratory.	IS: 15713 or ISO-15500
		LNG regulator and Vaporizer/heat exchanger shall meet requirements of UN R110 or equivalent standard	UN R 110 or equivalent standard
		HCNG regulator shall meet requirements of IS/ISO 12619 or equivalent standard	IS/ISO 12619 or equivalent standard
4	Gas-Air Mixer*	Testing of the component as per IS :15714 or ISO-15500 by test agency. Alternatively, test agency to verify the test certificate or report conforming to the above standard issued by accredited testing laboratory.	IS: 15714 or ISO-15500
5	Gas Injector*	Testing of the component as per ISO-15500-7 by test agency. Alternatively, test agency to verify the test certificate or report conforming to the above standard issued by accredited testing laboratory.	ISO-15500-7
		HCNG Gas Injector shall meet requirements of IS/ISO 12619 or equivalent standard	IS/ISO 12619 or equivalent standard

6	Petrol Solenoid Valve*	Testing of the component as per IS: 15717 by test agency. Alternatively, test agency to verify the test certificate or report conforming to the above standard issued by accredited testing laboratory.	IS: 15717
6.1	Gas Solenoid Valve / Automatic Shutoff valve*	Testing of the component as per IS: 15712 or ISO-15500 by test agency. Alternatively, test agency to verify the test certificate or report conforming to the above standard issued by accredited testing laboratory.	IS: 15712 or ISO-15500
		Automatic shutoff valve of LNG System (which comes in contact with LNG shall meet requirements of UN R110 or equivalent standards)	Automatic shutoff Valve for LNG System : UN R110 or equivalent standards
		HCNG Gas Solenoid Valve / Automatic Shutoff valve shall meet requirements of IS/ISO 12619 or equivalent standard	IS/ISO 12619 or equivalent standard
7	Filling Connection (NZS & NGV-1 type)	Installation on vehicle to be checked by test agency as per AIS-028	Clauses 2.2.2, 2.2.3, 2.2.4, 2.2.5 and 2.2.6 of AIS-028 (Rev. 1) (Part A)
	HCNG receptacle		
	LNG receptacle		
8	Ventilation	Test agency to verify.	Clause 2.4.2 of AIS-028 (Rev. 1) (Part A)

9	Testing of Conduit*	Testing of the component or verification of certificate or test report as per IS: 15715 by test agency.	IS: 15715
10	CNG / BIO-CNG/LNG/H CNG fuel line		
10.1	High pressure — exceeding 100 kPa*		
10.1.1	Exceeding 2.15 MPa		
	-Rigid pipe	Testing of the component or verification of certificate or test report as per IS: 15716 by test agency.	IS: 15716
		LNG rigid pipeline shall meet requirements of UN R110 or IS: 15716 or equivalent standard	UN R110 or IS: 15716 or equivalent standard.
		HCNG Rigid Pipe shall meet requirements of IS/ISO 12619 or equivalent standard	IS/ISO 12619 or equivalent standard
	-Flexible hose	Testing of the component or verification of certificate or test report as per IS 15718 by test agency.	IS 15718 or AIS-028 (Rev. 1) (Part A)
		LNG flexible pipeline shall meet requirements of UN R110 or IS: 15718 or equivalent standard.	UN R110 or IS:15718 or equivalent standard
		HCNG Flexible hose shall meet requirements of IS/ISO 12619 or equivalent standard	IS/ISO 12619 or equivalent standard
10.1.2	Pressure upto 2.15 Mpa	Testing of the component or verification of certificate or test report as per IS: 15722 by test agency.	IS: 15722 with amendments

		LNG pipeline shall meet requirements of UN R110 or IS: 15722 or equivalent standard.	UN R110 or IS: 15722 or equivalent standard
		HCNG Pipeline shall meet requirements of ISO 12619 or equivalent standard	ISO 12619 or equivalent standard
10.2	Joints and connections*	Testing by test agency.	Clause 3.1.4.1, 3.2.1 (b) of AIS-028 (Rev. 1) (Part A)
		LNG joints & connection shall meet requirements of UN R110 or equivalent standard	UN R110 or equivalent standard
		Testing by test agency as per Clause 3.1.4.1, 3.2.1 (b) of AIS-028 (Rev. 1) (Part A).	
11	Compartment or Sub-compartment*	Testing of the component or verification of certificate or test report as per IS: 15720 by test agency.	IS: 15720
12	Specific LNG components	Following specific components, as applicable shall meet requirements of UN R 110 or equivalent standard <ul style="list-style-type: none"> LNG Fuel pump , Pressure Relief valves, Pressure sensor, check valve, excess flow valve, manual valve and non-return valve. 	UN R 110 or equivalent standard
13	Safety check for installation of of Gaseous fuel system	Safety checks to be carried out by test agency as per AIS-028.	Relevant clauses of AIS-028 (Rev. 1) (Part A)

* Certificate issued by accredited testing agency of the country of origin or a report issued by internationally accredited test laboratory may also be accepted.

NOTE 1 - Only the standards, as amended from time to time, as mentioned above, shall be referred for compliance.

Note 2 - Components downstream the Heat exchanger/vaporizer shall be considered as CNG components and prevailing Indian standard /ISO standard or equivalent standards shall be acceptable.

Note 3 – Test agency to conduct applicable CMVR test with LNG fuel as notified by Govt of India

AMENDMENT No. 4 (12/2023)

To

AIS-028 (Rev 1) (Part A)

Code of Practice for use of Gaseous Fuels in Internal Combustion Engine Vehicle

1.0 Add following new clause 1.3.26 after clause 1.3.25

1.3.25 Hydrogen blend in Compressed natural gas (CNG / BIO CNG):- A mixture of Natural gas and Hydrogen shall be used as specified by the Government of India from time to time.

2.0 Clause 2.3.1.3

Substitute following text with existing text

2.3.1.3 The cylinder shall be situated and vented so that any gas escaping due to leakage from the cylinder valve shall not enter the vehicle passenger compartment or driver space. In case of fire, the requirement of venting gas to the outside of the vehicle does not apply.

3.0 Clause 2.3.4

Substitute following text with existing text

2.3.4 Internal cylinders Where a cylinder is located within the body shell of a vehicle, either:

(a) The whole body of the cylinder together with its attached components and fittings shall be enclosed in a compartment; or

(b) The valves and pipe connections associated with or attached to the cylinder shall be enclosed in a localized sub-compartment, which is attached to the cylinder and vented to the atmosphere.

Provision shall be made for access to the cylinder valve in all installation arrangements.

4.0 Clause 3.1.1

Add following text at the end

HCNG rigid pipeline and connections (Stainless Steel) shall meet requirements of ISO 12619 or equivalent standards.

5.0 Clause 3.1.2

Add following text at the end

HCNG rigid pipeline and connections (Stainless Steel) shall meet requirements of ISO 12619 or equivalent standards.

6.0 Clause 3.1.3.1

Add following text at the end

HCNG Flexible hose shall meet requirements of ISO 12619 or equivalent standards.

7.0 Clause 3.1.5.1 (e)

Substitute following text with existing text

3.1.5.1 High pressure piping and hoses in vehicles shall comply with the following:

- (e) Use of the wheel arch for fuel line location is not desirable or recommended. However, in case of routing through wheel arch, flexible fuel line shall be covered with metallic protection / metallic clamping and rigid fuel line shall be protected with metallic / plastic covering.

8.0 Clause 3.2.1

Add following text at the end

HCNG Flexible hose shall meet requirements of ISO 12619 or equivalent standards.

9.0 Clause 4.2.2.2

Substitute following text with existing text

4.2.2.2 Service shut-off valve: As required, an optional service shut-off valve (other than service shut off valve fitted on gas cylinders) may be installed in high pressure fuel line between the cylinder valve and any other valve or component within the engine compartment and as close as practicable to the Regulator, however it is acceptable to install the valve at the refueling point. It shall be possible to operate the valve in the installed position during refuelling operation. A permanent label shall be provided 'CNG / BIO-CNG /LNG service shut-off valve' or similar wording to positively indicate its purpose and a positive indication of "Closed" and "Open" positions of the valve shall be clearly marked.

10.0 Add new clause 6.1.1.4 after clause 6.1.1.3

6.1.1.4 Label for HCNG fueled vehicle shall in accordance with appendix C5.

11.0 Clause 6.1

Substitute following text for existing text:

6.1 Identification labels (for vehicles other than two wheelers)

12.0 Add following new clause 6.2 after clause 6.1.2.2

- 6.2 Identification labels (for two wheelers)
- 6.2.1 Vehicles running with CNG/Bio-CNG shall be labeled as follows (Dedicated/Bi-fuel):

One label of size of 35 mm x 35 mm (see figure 6.2.1) shall be affixed at prominent location on vehicle. Label shall have on them the text “CNG” or “BIO CNG” as applicable, in a central position not less than 12 mm high. The label shall have a black border 0.8 mm wide, 2 mm inside the outer edge and running parallel to it. The 35 mm dimension is measured from the outer edge.



Figure

- 6.2.2 The label shall be in position at all times, shall be in good condition, and the shape, colouring and lettering shall be easily identifiable.
- 6.2.3 The sticker shall be weather resistant.
- 6.2.4 A label shall be placed adjacent to the CNG fill receptacle stating the fuelling requirements. The fuelling requirements shall be as recommended in this standard.
- 6.2.5 Colour requirements:
- 6.2.5.1 For CNG Vehicles: CNG letter shall be in black colour on white background.
- 6.2.5.2 For Bio-CNG Vehicles: BIO CNG letters shall be in green colour on white background.

13.0 Appendix C1, C2, C3 and C4, third row below table

Substitute following text for existing text:

The fuelling requirements shall be as recommended in this standard.

14.0 Add following new Appendix C5 after Appendix C4

APPENDIX C-5

LABEL

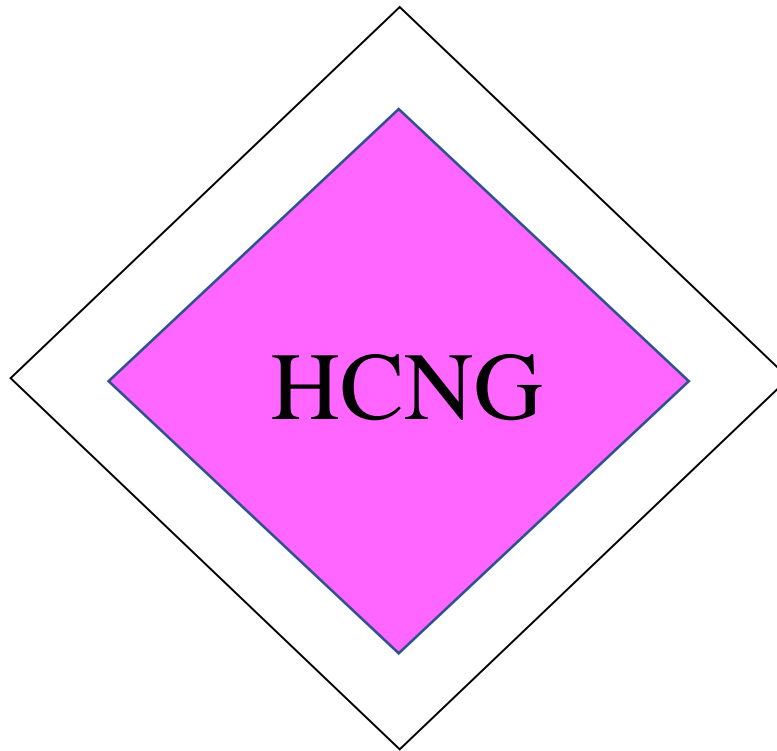

The sign consists of a sticker which shall be weather resistant.

The colour and dimensions of the sticker shall fulfil the following requirements:

A label shall be placed adjacent to the HCNG fill receptacle stating the fuelling requirements. The fuelling requirements shall be as recommended in this standard.

Colours:	
Background	Pink
Letters:	Black or black reflecting
Dimensions:	
Border width:	4 - 6 mm
Character height:	≥ 25 mm
Character thickness:	≥ 4 mm
Sticker width:	110 - 150 mm
Sticker height:	80 - 110 mm

The word "HCNG" shall be centred in the middle of the sticker

PRINTED BY
THE AUTOMOTIVE RESEARCH ASSOCIATION OF INDIA
P. B. NO. 832, PUNE 411 004

ON BEHALF OF
AUTOMOTIVE INDUSTRY STANDARDS COMMITTEE

UNDER
CENTRAL MOTOR VEHICLES RULES - TECHNICAL STANDING COMMITTEE

SET-UP BY
MINISTRY OF ROAD TRANSPORT & HIGHWAYS
(DEPARTMENT OF ROAD TRANSPORT & HIGHWAYS)
GOVERNMENT OF INDIA

20th December 2023

AMENDMENT No. 3 (07/2022)
to
AIS-024 (Rev 1) (Part A)
Safety and Procedural Requirements for Type Approval of Gaseous Fueled
Vehicles

AMENDMENT No. 3 to AIS-028 (Rev 1) (Part A)
Code of Practice for use of Gaseous Fuels in Internal Combustion Engine Vehicle

1.0 Page No. 85/107, Clause 6.0, sub-clause 6.1.1.2

“Label shall be coloured white and sized 80 mm x 80 mm square. Label shall have on them the text “CNG” in a central position not less than 20 mm high, coloured black. The label shall have a black border 1 mm wide, 5 mm inside the outer edge and running parallel to it. The 80 mm dimension is measured from the outer edge. (Refer Appendix C-1 for drawing).

2.0 Page No. 85/107, Clause 6.0, sub-clause 6.1.2.2

“Label shall be coloured orange and sized 80 mm x 80 mm square. Label shall have on them the text “Diesel + CNG / LNG” in a central position not less than 15 mm high, coloured black. The label shall have a black border 1 mm wide, 5 mm inside the outer edge and running parallel to it. The 80 mm dimension is measured from the outer edge. (Refer Appendix C-2 for drawing).”

3.0 Page No. 95/107, Appendix C-3

Delete the Appendix C-3

PRINTED BY
THE AUTOMOTIVE RESEARCH ASSOCIATION OF INDIA
P. B. NO. 832, PUNE 411 004

ON BEHALF OF
AUTOMOTIVE INDUSTRY STANDARDS COMMITTEE

UNDER
CENTRAL MOTOR VEHICLES RULES - TECHNICAL STANDING COMMITTEE

SET-UP BY
MINISTRY OF ROAD TRANSPORT & HIGHWAYS
(DEPARTMENT OF ROAD TRANSPORT & HIGHWAYS)
GOVERNMENT OF INDIA

20th July 2022

AMENDMENT No. 3 (07/2022)
To
AIS-028 (Rev 1) (Part A)
Code of Practice for use of Gaseous Fuels in Internal Combustion Engine
Vehicles

1.0 Page No. 58/107, Add new clauses 1.3.2, 1.3.3 and 1.3.4 after clause 1.3.1 and re-number subsequent clauses.

1.3.2 Manufacturer means an organization or person or body which can assume technical responsibility for the manufacturing of LPG and NG retrofit systems and can demonstrate that it possesses the features required and the necessary means to achieve quality assessment and conformity of production.

1.3.3 For the purposes of this standard, "the parent vehicle", with regard both to LPG system and to NG system, means a vehicle that is selected to act as the vehicle, on which the requirements of this standard are going to be demonstrated, and to which the members of a family or layout refer.

1.3.4 Gaseous fuel system / kit' means an assembly of components (container(s) or cylinder(s), valves, flexible fuel lines, etc.) and connecting parts (rigid fuel lines, pipes fitting, etc.) fitted on motor vehicles using gaseous fuel in their propulsion system. – Inclusion in AIS 24/28 (Part A, B and C)

PRINTED BY
THE AUTOMOTIVE RESEARCH ASSOCIATION OF INDIA
P. B. NO. 832, PUNE 411 004

ON BEHALF OF
AUTOMOTIVE INDUSTRY STANDARDS COMMITTEE

UNDER
CENTRAL MOTOR VEHICLES RULES - TECHNICAL STANDING COMMITTEE

SET-UP BY
MINISTRY OF ROAD TRANSPORT & HIGHWAYS
(DEPARTMENT OF ROAD TRANSPORT & HIGHWAYS)
GOVERNMENT OF INDIA

20th July 2022

AMENDMENT No. 2 (07/2022)
to
AIS-024 (Rev 1) (Part A)
Safety and Procedural Requirements for Type Approval of Gaseous Fueled Vehicles

AMENDMENT No. 2 to AIS-028 (Rev 1) (Part A)
Code of Practice for use of Gaseous Fuels in Internal Combustion Engine Vehicle

1.0 Page No.III, Contents

Insert Sr.No-2A After Sr.No-2 “Annexure I

Sr.No.	Document	Description
2A	Annexure IA	Additional information to be given by retrofitter in addition to information given in Annexure

2.0 Page No. 1/107, In table “SAFETY AND PROCEDURAL REQUIREMENTS FOR TYPE APPROVAL OF GASEOUS FUELLED VEHICLES”

For the words and figures, “Annexure I” the words and figures “Annexure I & Annexure IA” shall be substituted

3.0 Page No. 3/107, Insert Annexure IA, after Annexure I

Annexure IA

Additional information to be given by retrofitter in addition to information given in Annexure I

1.0 APPLICATION FOR TYPE APPROVAL

Application for approval of retro fitment shall be submitted by the retrofitter or by his duly accredited representative along with detailed description of all the modifications applied to the original vehicle including a copy of the following manuals / documents:

- a. Description of the retrofit system comprising all the relevant details, included the approval numbers of each component referred to Annexure I of this standard.
- b. Description of the parent vehicle(s) on which the requirements are going to be tested.
- c. Description of all modifications applied to the original parent vehicle, only in case of bi-fuel configuration;
- d. Instruction manual for the retrofit installation on vehicles; which shall contain at least following information:
 1. Retrofit system description and its operating principle.
 2. Detailed procedures and actions which shall be taken by the installer to check whether the system has been assembled in order to safely perform and to abide by the installation instructions.
 3. Start-up operations which shall be performed by the installer.

4. Maintenance schedule in which all the ordinary service (type) which the single components as well as the system shall undergo through their working life (time in km covered by the vehicle) will be specified.
 5. The installation manual shall specify the expertise necessary for the installation/service of the system.
 6. The installation manual shall contain the actions which shall be taken in case the system malfunctions.
 7. If a diagnosis system is included in the conversion kit, the installation manual shall contain a detailed description of such a system together with the corrective actions which may be taken in case of malfunctioning.
 8. Assembly instructions of all components together with diagrams or photographs showing clearly the layout of the single components within the engine compartment.
 9. Clear wiring diagram of the electrical system containing the mechanical components to which the wires shall be connected.
- e. service station manual and
- f. End-user manual including warranty parameters.

Retrofitter will be responsible for Warranty for: -

1. All the retrofitted parts / systems / subsystems
2. Any modifications made on vehicle engine / frame or electrical components for the fitment of retro fitment system and related failure.
3. Any alteration to the vehicle which is directly or indirectly linked with OE components and likely to have any adverse effect.

4.0 Page No. 22/107, “ANNEXURE V, Clause 3.0

Insert new Sr. No. “v” after Sr. No. “u” :

v) 5 gas analyzer

5.0 Page No. 23/107, “ANNEXURE V, Clause 4.0

Substitute the following text for existing text:

Each retro fitment center shall have minimum of three (03) trained staff. Installer shall have trained technicians having minimum ITI /Diploma qualification with at least five year of experience for ITI candidate and two years of experience for Diploma candidate in the similar field. Vehicle / kit manufacturer / supplier to impart extensive training to the technicians on gas kit installation including software and calibration. The training module should cover the changes / alteration to be carried out on the vehicle as per end user; installation manual.

The training module should cover the training required to carry out changes / alteration to the vehicle as per the instructions given in installation manual.

6.0 Page No. 24/107, “ANNEXURE V,

Add new Sr. No 8 and make it reserved.

7.0 Page No. 24/107, “ANNEXURE V, Clause 9.0

Renumber the exiting clauses 9.0 as 9.0 (a) and 9.0(b).

8.0 Page No. 24/107, “ANNEXURE V,

Insert the following clause after clause 9.0(b)

9.0 (c) The Installer shall inform and educate the customer on the alterations carried out on the vehicle model and warranty coverage.

9.0 Page No. 24/107, “ANNEXURE V, Clause 10.0

Substitute following text for existing text:

The record of conversion / alteration of vehicles carried out by the kit installer shall be maintained in electronic format covering the history of fitment, servicing etc. In addition, Installer shall conduct fitness and performance checks of the converted/ retrofitted vehicle once in a year and maintain the audited parameters and observations in electronic format as per the norms established by the kit supplier/ manufacturer. The information shall be made available to the authorities such as MORTH / Test Agencies / Transport Authorities as and when demanded.

PRINTED BY

THE AUTOMOTIVE RESEARCH ASSOCIATION OF INDIA

P. B. NO. 832, PUNE 411 004

ON BEHALF OF

AUTOMOTIVE INDUSTRY STANDARDS COMMITTEE

UNDER

CENTRAL MOTOR VEHICLES RULES - TECHNICAL STANDING COMMITTEE

SET-UP BY

MINISTRY OF ROAD TRANSPORT & HIGHWAYS

(DEPARTMENT OF ROAD TRANSPORT & HIGHWAYS)

GOVERNMENT OF INDIA

20th July 2022

AMENDMENT No. 1 to AIS-024 (Rev 1) (Part A) (01/2021)

Safety and Procedural Requirements for Type Approval of Gaseous Fuelled Vehicles

AMENDMENT No. 1 to AIS-028 (Rev 1) (Part A) (01/2021)

Code of Practice for use of Gaseous Fuels in Internal Combustion Engine Vehicles

1.0 Page No. 26/107, Annexure VI, Clause A, Serial No. 3

Substitute the following text for existing text:

“Category of vehicle converted as per CMVR, 1989”

2.0 Page No. 27/107, Annexure VI, Clause C, Serial No. 2

Delete sub clauses b.1 and b.2

3.0 Page No. 27/107, Annexure VI, Clause C, Serial No. 3

Delete sub-clause c

4.0 Page No. 27/107, Annexure VI, Clause C, Serial No. 4

Delete sub-clause c

5.0 Page No. 27/107, Annexure VI, Clause C, Serial No. 6

Add following sub-clause b after sub-clause a

b) Type

6.0 Page No. 27/107, Annexure VI, Clause C, Serial No. 7, sub-clause c

Substitute word “Sr. No.” with for “TAC No.”

7.0 Page No. 27/107, Annexure VI, Clause C, Serial No. 8, sub-clause b

Substitute word “type” for words “Identification No.”

8.0 Page No. 76/107, Clause 3.1.5.1, sub-clause g

Substitute the following text for existing text:

“Rigid fuel lines shall be effectively secured to the chassis frame or vehicle body by clips spaced not more than 300 mm apart for 2 and 3 wheelers and 600 mm apart for other vehicles. In order to prevent the possibility of fretting corrosion or erosion of the fuel line cushioning must be provided to protect the fuel line from both the chassis/body and the clips themselves. Suitable

grommets must be provided where the fuel line passes through anybody panel.”

9.0 Page No. 82/107, Clause 4.2.5.1, sub-clause c

Substitute the following text for existing text:

“Dedicated fuel type: A dedicated system is defined as a system equipped to operate wholly on CNG/BIO CNG/LNG.”

10.0 Page No. 84/107, Clause 5.0, Compliance plate, sub-clause f

Substitute the following text for existing text:

“The gaseous fuel installation complies with the safety requirements of AIS 028”

11.0 Page No. 84/107, Clause 6.0, sub-clause 6.1.1

Substitute following text for existing text

“Labels conforming with the specification given in 6.1.1.1 of this standard shall be affixed in a vertical position as close to the vehicle number plate as practical or on the left side of the front and rear safety glass and shall ensure visibility from the front and rear sides.”

12.0 Page No. 93/107, Appendix C-1

Substitute the following figure for CNG



13.0 Page No. 95/107, Appendix C-3

Substitute the following figure for BIO CNG



PRINTED BY
THE AUTOMOTIVE RESEARCH ASSOCIATION OF INDIA
P. B. NO. 832, PUNE 411 004

ON BEHALF OF
AUTOMOTIVE INDUSTRY STANDARDS COMMITTEE

UNDER
CENTRAL MOTOR VEHICLES RULES - TECHNICAL STANDING COMMITTEE

SET-UP BY
MINISTRY OF ROAD TRANSPORT & HIGHWAYS
(DEPARTMENT OF ROAD TRANSPORT & HIGHWAYS)
GOVERNMENT OF INDIA

12th January 2021

AUTOMOTIVE INDUSTRY STANDARD

AIS-024

**SAFETY AND PROCEDURAL REQUIREMENTS
FOR TYPE APPROVAL OF GASEOUS FUELLED
VEHICLES**

REVISION-I

PART A (AUTOMOTIVE APPLICATION)

AND

AIS-028

**CODE OF PRACTICE FOR USE OF GASEOUS FUELS
IN INTERNAL COMBUSTION ENGINE VEHICLES**

REVISION-I

PART A (AUTOMOTIVE APPLICATION)

PRINTED BY
THE AUTOMOTIVE RESEARCH ASSOCIATION OF INDIA
P.B. NO. 832, PUNE 411 004

ON BEHALF OF
AUTOMOTIVE INDUSTRY STANDARDS COMMITTEE

UNDER
CENTRAL MOTOR VEHICLE RULES – TECHNICAL STANDING COMMITTEE

SET-UP BY
MINISTRY OF ROAD TRANSPORT & HIGHWAYS
(DEPARTMENT OF ROAD TRANSPORT & HIGHWAYS)
GOVERNMENT OF INDIA

September 2020

INTRODUCTION

The Government of India felt the need for a permanent agency to expedite the publication of standards and development of test facilities in parallel when the work on the preparation of the standards is going on, as the development of improved safety critical parts can be undertaken only after the publication of the standard and commissioning of test facilities. To this end, the erstwhile Ministry of Surface Transport (MOST) has constituted a permanent Automotive Industry Standards Committee (AISC) vide order No. RT-11028/11/97-MVL dated September 15, 1997. The standards prepared by AISC will be approved by the permanent CMVR Technical Standing Committee (CMVR-TSC). After approval, the Automotive Research Association of India, (ARAI), Pune, being the Secretariat of the AIS Committee, will publish this standard. For better dissemination of this information ARAI may publish this document on their Web site.

Revision 1 of AIS-024 and AIS-028 is prepared to include safety and procedural requirements for type approval of gaseous fuel operated vehicles using Dedicated / Bi-Fuel / Dual Fuel / Dedicated Dual Fuel technology as applicable. Part A of AIS-024 and AIS-028 (Rev.1) deals with Automotive Applications.

The AISC panel responsible for formulation of this standard is given in Annexure XI.

The Automotive Industry Standards Committee (AISC) responsible for approval of this standard is given in Annexure XII.

CONTENTS

Sr. No.	Document	Description	Page No.
1.	AIS-024 (Revision 1) (Part A)	Safety and procedural requirements for type approval of Gaseous fuelled vehicles	1/107
2.	Annexure I	Technical specification of Gaseous fuelled vehicles kit (Dedicated / Bi-Fuel / Dual Fuel / Dedicated Dual Fuel as applicable)	3/107
3.	Annexure II	Technical specification of in-use vehicles	13/107
4.	Annexure III	Checklist for fitness tests and certification for in-use vehicles after fitment / conversion to gaseous fuel mode (Dedicated / Bi-Fuel / Dual Fuel / Dedicated Dual Fuel as applicable)	16/107
5.	Annexure IV	Safety checks for use of Gaseous fuelled (Dedicated / Bi-Fuel / Dual Fuel / Dedicated Dual Fuel as applicable) internal combustion engine vehicles (as per AIS-028 (Rev.1) (Part A)) & Indian Gas cylinder rules 2016 (as amended from time to time)	18/107
6.	Annexure V	Criteria to authorize the kit installer and responsibility of kit manufacturer / supplier / installer applicable to Gaseous fuelled vehicles (Dedicated / Bi-Fuel / Dual Fuel / Dedicated Dual Fuel as applicable)	22/107
7.	Annexure VI	Installation Certificate for Converted /OE Gaseous Fuelled Vehicle (Dedicated / Bi-Fuel / Dual Fuel / Dedicated Dual Fuel As Applicable) (To Be Filled In By Installer/OE)	26/107
8.	Annexure VII	Checklist for third party checking / inspection of built up gaseous fuel operated Buses (New and Converted / In-use and Retrofitted) Before Registration (Dedicated / Bi-Fuel / Dual Fuel / Dedicated Dual Fuel as applicable)	29/107
9.	Annexure VIII	Checklist for preventive maintenance of in-use Gaseous fuelled vehicles (Dedicated / Bi-Fuel / Dual Fuel / Dedicated Dual Fuel as applicable)	38/107

AIS-024 (Rev.1) (Part A)

10.	Annexure IX	Checklist for third party checking / inspection of Gaseous fuel vehicles (other than gaseous fuel buses) (New and Converted / In-use and Retrofitted) before registration (Dedicated / Bi-Fuel / Dual Fuel / Dedicated Dual Fuel as applicable)	43/107
11.	Annexure X	Tests to be carried out by Test Agency On Gaseous fuel vehicles (Dedicated / Bi-Fuel / Dual Fuel / Dedicated Dual Fuel as applicable)	54/107
12.	AIS-028 (Rev. 1)(Part A)	Code of Practice for use of Gaseous Fuels in Internal Combustion Engine Vehicles	57/107
13.	Annexure XI	AISC Panel Composition	106/107
14.	Annexure XII	Automotive Industry Standards Committee Composition	107/107

SAFETY AND PROCEDURAL REQUIREMENTS FOR TYPE APPROVAL OF GASEOUS FUELLED VEHICLES			
	For OE Manufacturer (Dedicated / Bi-Fuel / Dual Fuel / Dedicated Dual Fuel as applicable)	For Retro fitment of In-Use vehicle (Dedicated / Bi-Fuel / Dual Fuel / Dedicated Dual Fuel as applicable)	For Replacement of In-Use Diesel Engine by New Gaseous Engine
Documents to be submitted	Detailed and brief technical specifications of vehicle (as per AIS-007 (Rev.5) as amended from time to time).	Annexure I.	Annexure I.
		Annexure II.	Annexure II.
			Technical specification of replaced diesel engine as per AIS-007 (Rev.5) as amended from time to time).
CMVR Checks	CMVR checks / tests are to be conducted by Test Agency as per prevailing CMVR 1989 norms.	Annexure III	Annexure III
		Assessment of structural integrity in case of diesel vehicles to be provided by the retrofitter or kit installer.	Assessment of structural integrity in case of diesel vehicles to be provided by the retrofitter or kit installer.
Performance Tests as per CMVR	As per Annexure X-a of AIS-024 (Rev. 1) (Part A).	As per Annexure X-b of AIS-024 (Rev. 1) (Part A).	As per Annexure X-c of AIS-024 (Rev. 1) (Part A).

AIS-024 (Rev.1) (Part A)

Safety Checks as per AIS-028 (Rev. 1)(Part A)	As given in Annexure IV of AIS-024 (Rev. 1) (Part A).	As given in Annexure IV of AIS-024 (Rev. 1) (Part A).	As given in Annexure IV of AIS-024 (Rev. 1) (Part A).
Criteria to authorize kit installer and responsibility of the vehicle / kit manufacturer / supplier / installer	-	As given in Annexure V of AIS-024 (Rev. 1) (Part A).	As given in Annexure V of AIS-024 (Rev. 1) (Part A).
Format of installation certificate for converted CNG / BIO-CNG / LNG vehicle	As per Annexure VI of AIS-024 (Rev. 1) (Part A).	As per Annexure VI of AIS-024 (Rev. 1) (Part A).	As per Annexure VI of AIS-024 (Rev. 1) (Part A).
Checklist for preventive maintenance of in-use vehicles	-	As per Annexure VIII of AIS-024 (Rev. 1) (Part A).	As per Annexure VIII of AIS-024 (Rev. 1) (Part A).

ANNEXURE I

**TECHNICAL SPECIFICATION OF GASEOUS FUELLED VEHICLES KIT
(DEDICATED / BI-FUEL / DUAL FUEL / DEDICATED DUAL FUEL AS
APPLICABLE)**

1. Details of Kit Manufacturer / Supplier / Installer	
a) Name of the Manufacturer	
b) Address	
c) Telephone No. & Fax No.	
2. Gas Kit Identification	
a) Identification No.	
b) Variants, if any	
c) Fuel system (Dedicated / Bi-Fuel / Dual Fuel / Dedicated Dual Fuel)	
d) Type of Dual- fuel system (Type 1A / 1B / 2A / 2B / 3B)	
e) Fuel (Gas Fuel (Specify Name of fuel) & Gasoline / Diesel)	
3. Cylinder Details (PESO approved / endorsed)	
a) Name of manufacturer	
b) Identification No.	
c) Type	
d) Working pressure (kg/cm ²)	
e) Max. test pressure (kg/cm ²)	
f) Cylinder capacity (water equivalent) (liters) and diameter (mm)	
g) Approval reference from PESO (PESO compliance with Date)	
h) Number of Cylinders fitted (schematic drawing)	

Manufacturer :	Document No :	Test Agency :	Cert No :
Signature		Signature	
		Name	
	Sheet No	Designation	
Designation	Date	Date of Issue	Page No of

i) Tare weight of each cylinder (kg)	
j) Approval reference (PESCO compliance with Date)	
4. Cylinder Valve (s) / Shutoff valve (PESCO approved / endorsed)	
a) Name of manufacturer	
b) Model name/Identification No.	
c) Type	
d) Working pressure (kg/cm ²)	
e) Max. test pressure (kg/cm ²)	
f) Approval reference from PESCO (PESCO compliance with Date)	
5. Solenoid Valve / Automatic shutoff valve	
a) Name of manufacturer	
b) Model Name / Identification No.	
c) Type	
d) Working pressure (kg/cm ²)	
e) Max test pressure (kg/cm ²)	
f) Approval reference (Test Report / Approval Number)	
6. Petrol Solenoid Valve	
a) Name of manufacturer	
b) Model Name / Identification No.	
c) Type	
d) Working pressure (kg/cm ²)	

Manufacturer :	Document No :	Test Agency :	Cert No :
Signature		Signature	
		Name	
	Sheet No		
Designation	Date	Date of Issue	Page No of

e) Max test pressure (kg/cm ²)	
7. Refilling valve / Refilling Receptacle	
a) Name of the manufacturer	
b) Model name / Identification No.	
c) Type	
d) Working pressure (kg/cm ²)	
e) Max test pressure (kg/cm ²)	
8. Pressure Regulator	
a) Name of manufacturer	
b) Model name / Identification No.	
c) Type	
d) Inlet pressure (kg/cm ²)	
e) Outlet pressure (kg/cm ²)	
f) No. of stages	
g) Approval reference (Test Report / TAC compliance with Date)	
9. Vaporizer / Heat exchanger (for LNG)	
a) Name of manufacturer	
b) Model name / Identification No.	
c) Type	
d) Inlet pressure (kg/cm ²)	
e) Outlet pressure (kg/cm ²)	
f) Approval reference (Test Report / Approval Number)	

Manufacturer :	Document No :	Test Agency :	Cert No :
Signature		Signature	
		Name	
	Sheet No		
Designation	Date	Date of Issue	Page No of

10. Filter	
a) Name of manufacturer	
b) Model name / Identification No.	
c) Type	
d) Inlet pressure (kg/cm ²)	
e) Outlet pressure (kg/cm ²)	
11. Oil Pump or Lubrication System, if applicable	
a) Name of manufacturer	
b) Type	
12. High Pressure Tubing	
a) Name of manufacturer	
b) Model name / Identification No.	
c) Type (rigid / flexible)	
d) Working pressure (kg/cm ²)	
e) Max. test pressure (kg/cm ²)	
f) Outer diameter / Inner Diameter (mm)	
g) Material	
h) Approval reference (Test Report / Approval Number)	
13. Low Pressure Tubing	
a) Name of manufacturer	
b) Model name / Identification No.	
c) Type	

Manufacturer :	Document No :	Test Agency :	Cert No :
Signature		Signature	
		Name	
	Sheet No		
Designation	Date	Date of Issue	Page No of

d) Working pressure (kg/cm ²)	
e) Max test pressure (kg/cm ²)	
f) Outer diameter / Inner Diameter (mm)	
i) Material	
j) Approval reference (Test Report / Approval Number)	
14. Gas-Air Mixer	
a) Name of manufacturer	
b) Model name / Identification No	
c) Type & drawing	
d) Venturi Size (mm)	
e) Approval reference (Test Report / Approval Number)	
15. Gas Injector	
a) Name of manufacturer	
b) Model name / Identification No	
c) Type & drawing	
d) Injector flow specs	
e) Approval reference (Test Report / Approval Number)	
16. ON / OFF Switch (Fuel selector switch)	
a) Name of manufacturer	
b) Model name / Identification No	
17. Ignition System	

Manufacturer :	Document No :	Test Agency :	Cert No :
Signature		Signature	
		Name	
	Sheet No		
Designation	Date	Date of Issue	Page No of

a) Name of manufacturer	
b) Type of Ignition System	
c) Spark plug gap, mm	
d) Make	
e) Identification	
18. Wiring Harness	
a) Name of manufacturer	
b) Electrical circuit diagram / Detail layout	
c) Approval reference (Test Report / Approval Number)	
19. Interfacing Unit (ECU)	
a) Name of manufacturer	
b) Identification No.	
c) Type	
20. Ignition Timing Advancer	
a) Name of manufacturer	
b) Type	
c) Timing on Gas mode	
d) Timing on baseline fuel.	
21. Fuel selector switch	
a) Name of manufacturer	
b) Model No	
c) Type	
20.Fuel flow actuation mechanism (Mechanical / Electronic)	

Manufacturer :	Document No :	Test Agency :	Cert No :
Signature		Signature	
		Name	
	Sheet No		
Designation	Date	Date of Issue	Page No of

a) Brief description of system (Attach Annexure)	
b) Schematic layout (Attach Drawing)	
c) Identification of critical components of Kit, including ECU, Lambda sensor, Pressure sensor, temperature Sensor etc with Make and Identification number) (attach Annexure)	
21. Brief Description of System Including Dimensional Layout for Cylinder and other kit components installation ventilation details etc.	
22. Joints and connections	
a) Name of manufacturer	
b) Type	
c) Number of Joints and connections represented on Drawing (Attach Drawing)	
23. Catalytic Converter OE	
(a) Make & identification Replaced	
(b) Make & identification	
24. Refilling valve interlocking switch (NA for LNG)	
a) Name of manufacturer	
b) Identification No.	
c) Type	
25. Current limiting Device (Fuse)	
a) Name of manufacturer	
b) Identification No.	
c) Voltage / current rating	
d) Type	

Manufacturer :	Document No :	Test Agency :	Cert No :
Signature		Signature	
		Name	
	Sheet No		
Designation	Date	Date of Issue	Page No of

e) Approval reference (Test Report / Approval Number)	
26. Indicator	
(A) Pressure Indicator	
a) Name of manufacturer	
b) Identification No.	
c) Type	
(B) Temperature Indicator (for LNG)	
a) Name of manufacturer	
b) Identification No.	
c) Type	
27. Service shut off valve	
a) Name of manufacturer	
b) Identification No.	
c) Type	
28. Compartment/Sub-compartment / Gas tight housing	
a) Name of manufacturer	
b) Identification No	
c) Type	
d) Material used	
e) Approval reference (Test Report / Approval Number)	
29. Conduit	
a) Name of manufacturer	

Manufacturer :	Document No :	Test Agency :	Cert No :
Signature		Signature	
		Name	
	Sheet No		
Designation	Date	Date of Issue	Page No of

b) Identification No.	
c) Inner & outer diameter	
d) Type	
e) Approval reference (Test Report / Approval Number)	
30. Details of non-moisture retaining hard rubber / equivalent material padding / lining provided for inner side of the cylinder mounting band(s)	
a) Name of manufacturer	
b) Identification No.	
c) Type	
d) Number of bands / cylinder (Should be part of layout)	
e) Approval reference (Test Report / Approval Number)	
31. Battery cut off switch (if applicable)	
(a) Name of manufacturer	
(b) Identification No.	
(c) Type	
32. Labels - Number and position	
33. First Aid Box	
34. Fire Extinguisher (Number and Type)	
35. Idle rpm	
36. Brief Description of System Including Dimensional Layout for Cylinder and other kit components installation ventilation details etc.	
37. Any other information	

Manufacturer :	Document No :	Test Agency :	Cert No :
Signature		Signature	
		Name	
	Sheet No		
Designation	Date	Date of Issue	Page No of

Note: In case of OE fitment, if any of the above information is already covered in the information submitted as per AIS- 007, only the reference need be given and it is not necessary to duplicate the information.

*** Mention NA wherever not applicable**

Manufacturer :	Document No :	Test Agency :	Cert No :
Signature		Signature	
		Name	
	Sheet No		
Designation	Date	Date of Issue	Page No of

ANNEXURE II	
TECHNICAL SPECIFICATIONS OF IN-USE VEHICLES	
1.	Manufacturer's name and address
2.	Vehicle Data
	a) Model
	b) Category of Vehicle
	c) Year and Month of Manufacture
	d) Engine No.
	e) Chassis No.
	f) Registration number (Enclose RC copy)
	g) Application
3.	Engine
	a) Make
	b) Model
	c) Type
	d) Bore x stroke (mm)
	e) No. of cylinders
	f) Displacement
	g) Compression ratio
	h) Max. Engine output (kW @ rpm)
	i) Max. Torque (Nm @ rpm)
4.	Frame

Manufacturer :	Document No :	Test Agency :	Cert No :
Signature		Signature	
		Name	
	Sheet No		
Designation	Date	Date of Issue	Page No of

	a) Long member size (mm)	
	b) Number of cross members	
5.	Suspension	
	a) Type / Description	
	b) Spring	
	c) Anti-roll bar	
6.	Wheels and tyres	
	a) Wheel rim size	
	b) Tyre size designation including ply rating	
	c) Speed index	
	d) Load index / Load rating	
	e) Tyre Type (Radial / Cross / Tube / Tubeless)	
	f) Laden Tyre pressure (front & rear) (kg/cm ²)	
7.	Electrical system	
	a) System voltage (V)	
	b) Battery rating (Ah)	
8.	Fuel tank	
	a) Material	
	b) Capacity (l)	
9.	Dimensions	
	a) Wheel base (mm)	

Manufacturer :	Document No :	Test Agency :	Cert No :
Signature		Signature	
		Name	
	Sheet No		
Designation	Date	Date of Issue	Page No of

	b) Overall width (mm)	
	c) Overall length (mm)	
	d) Overall height (mm)	
	e) Front track (mm)	
	f) Rear track (mm)	
	g) Min. ground clearance (mm)	
	h) Cargo box dimensions (mm)	
	i) Load body platform area	
10.	Weights	
	a) Maximum GVW (kg)	
	b) Maximum GCW (kg)	
	c) Maximum FAW (kg)	
	d) Maximum RAW (kg)	
	e) Kerb weight with 90% fuel (with spare wheel, tools, etc.) (kg)	
	f) Maximum gradeability in 1st gear	
11.	Seating	
	a) Seating capacity	
	b) Sketch showing seating layout with dimensions	

Manufacturer :	Document No :	Test Agency :	Cert No :
Signature		Signature	
		Name	
	Sheet No		
Designation	Date	Date of Issue	Page No of

ANNEXURE III

**CHECKLIST FOR FITNESS TESTS AND CERTIFICATION FOR IN-USE
VEHICLES AFTER FITMENT / CONVERSION TO GASEOUS FUEL MODE
(DEDICATED / BI-FUEL / DUAL FUEL / DEDICATED DUAL FUEL AS
APPLICABLE)**

Sr. No.	Description	
1.	Spark plug / Suppression cap / HT cables	
2.	Head lights	
3.	Other lights	
4.	Reflectors	
5.	Bulbs	
6.	Rear view mirrors	
7.	Safety glass	
8.	Horn	
9.	Silencer	
10.	Sari guard, passenger hold	
12.	Dash board equipment	
13.	Windshield Wiper	
14.	Exhaust emission	
16.	Brake	
17.	Speedometer	
18.	Steering	
19.	Seat Belt	
20.	a. Suspension springs, viz.	
	b. No. of leaves	
	c. Size of flat (width and thickness) front and rear	
21.	Tyre, viz.	
	a. Size, ply rating	
	b. Condition of Tyre (New / Remolded)	

	c. Tread depth	
22.	Location of exhaust pipe	
23.	Overall Dimension, viz.	
	a. Length	
	b. Height	
	c. Width	
	d. Overhang	
24.	Structural Integrity	
	a. Changes to the chassis / vehicle body	
25.	Visual inspection of propeller shaft and universal joint to be carried out.	
26.	Rear Under run Protecting	
	a. Device For N2, N3, T3 and T4	
27.	Lateral Side Protection Device	
	a. For N2, N3, T3 and T4	

ANNEXURE IV

SAFETY CHECKS FOR USE OF GASEOUS FUELLED (DEDICATED / BI-FUEL / DUAL FUEL / DEDICATED DUAL FUEL AS APPLICABLE) INTERNAL COMBUSTION ENGINE VEHICLES (AS PER AIS-028 (REV.1) (PART A)) & INDIAN GAS CYLINDER RULES 2016 (AS AMENDED FROM TIME TO TIME)

Sr. No.	Gas Kit Component	Certifying / Verifying Authority	Clause of AIS-028 (Rev. 1) (Part A) / Other Rules, Standards, etc.
1	Gas Cylinder*	PESO, Nagpur to certify or endorse in case of foreign make	Gas cylinder rules 2016 as amended from time to time or as endorsed by PESO
1.1	Fitment of cylinder on vehicle	Test agency to verify as per AIS-028 (Rev.1) (Part A)	Clause no. 2.3, 2.5 and 2.6 of AIS-028 (Rev. 1)(Part A)
2	Gas Cylinder valves/Shut off valve *	PESO, Nagpur to certify or endorse in case of foreign make	IS: 3224 (for CNG valves), UN R110 (for LNG valves) or Gas cylinder rules 2016 or as endorsed by PESO
3	Regulator (For CNG & BIO-CNG) / Regulator and Vaporizer(LNG)*	Testing of the component as per IS: 15713 or ISO-15500 by test agency. Alternatively, test agency to verify the test certificate or report conforming to the above standard issued by accredited testing laboratory.	IS: 15713 or ISO-15500
		LNG regulator and Vaporizer/heat exchanger shall meet requirements of UN R110 or equivalent standard	UN R 110 or equivalent standard
4	Gas-Air Mixer*	Testing of the component as per IS: 15714 or ISO-15500 by test agency. Alternatively, test agency to verify the test certificate or report conforming to the above standard issued by accredited testing laboratory.	IS: 15714 or ISO-15500
5	Gas Injector*	Testing of the component as per ISO-15500-7 by test agency. Alternatively, test agency to verify the test certificate or report conforming to the above standard issued by accredited testing laboratory.	ISO-15500-7

6	Petrol Solenoid Valve*	Testing of the component as per IS: 15717 by test agency. Alternatively, test agency to verify the test certificate or report conforming to the above standard issued by accredited testing laboratory.	IS: 15717
6.1	Gas Solenoid Valve / Automatic Shutoff valve*	Testing of the component as per IS: 15712 or ISO-15500 by test agency. Alternatively, test agency to verify the test certificate or report conforming to the above standard issued by accredited testing laboratory.	IS: 15712 or ISO-15500
		Automatic shutoff valve of LNG System (which comes in contact with LNG shall meet requirements of UN R110 or equivalent standards)	Automatic shutoff Valve for LNG System : UN R110 or equivalent standards
7	Filling Connection (NZS & NGV-1 type)	Installation on vehicle to be checked by test agency as per AIS-028 (Rev. 1) (Part A)	Clauses 2.2.2, 2.2.3, 2.2.4, 2.2.5 and 2.2.6 of AIS-028 (Rev. 1) (Part A)
	LNG receptacle	LNG receptacle shall meet requirements of UN R 110 or equivalent standard	UN R 110 or equivalent standard
8	Ventilation	Test agency to verify.	Clause 2.4.2 of AIS-028 (Rev. 1) (Part A)
9	Testing of Conduit*	Testing of the component or verification of certificate or test report as per IS: 15715 by test agency.	IS: 15715
10	CNG / BIO-CNG / LNG fuel line		
10.1	High pressure exceeding 100 kPa*		
10.1.1	Exceeding 2.15 MPa		

	Rigid pipe	Testing of the component or verification of certificate or test report as per IS : 15716 by test agency.	IS: 15716
		LNG rigid pipeline shall meet requirements of UN R 110 or IS : 15716 or equivalent standard.	UN R 110 or IS: 15716 or equivalent standard.
	Flexible hose	Testing of the component or verification of certificate or test report as per IS 15718 by test agency.	IS 15718 or AIS-028 (Rev. 1) (Part A)
		LNG flexible pipeline shall meet requirements of UN R110 or IS: 15718 or equivalent standard.	UN R 110 or IS: 15718 or equivalent standard
10.1.2	Pressure upto 2.15 Bar	Testing of the component or verification of certificate or test report as per IS : 15722 by test agency.	IS : 15722 with amendments
		LNG pipeline shall meet requirements of UN R110 or IS : 15722 or equivalent standard.	UN R 110 or IS: 15722 or equivalent standard
10.2	Joints and connections*	Testing by test agency.	Clause 3.1.4.1, 3.2.1 (b) of AIS-028 (Rev. 1) (Part A)
		LNG joints & connection shall meet requirements of UN R 110 or equivalent standard	UN R 110 or equivalent standard
11	Compartment or Sub-compartment*	Testing of the component or verification of certificate or test report as per IS: 15720 by test agency.	IS: 15720
12	Specific LNG components	Following specific components, as applicable shall meet requirements of UN R 110 or equivalent standard <ul style="list-style-type: none"> LNG Fuel pump, Pressure Relief valves, Pressure sensor, check valve, excess flow valve, manual valve and non-return valve. 	UN R 110 or equivalent standard
13	Safety check for installation of Gaseous fuel system	Safety checks to be carried out by test agency as per AIS-028 (Rev.1) (Part A)	Relevant clauses of AIS-028 (Rev. 1) (Part A)

* Certificate issued by accredited testing agency of the country of origin or a report issued by internationally accredited test laboratory may also be accepted.

Note 1 - Only the standards, as amended from time to time, as mentioned above, shall be referred for compliance.

Note 2 - Components downstream the Heat exchanger / vaporizer shall be considered as CNG components and prevailing Indian standard / ISO standard or equivalent standards shall be acceptable

Note 3 - Test agency to conduct applicable CMVR test with LNG fuel as notified by Govt of India

ANNEXURE V

CRITERIA TO AUTHORIZE THE KIT INSTALLER AND RESPONSIBILITY OF KIT MANUFACTURER / SUPPLIER / INSTALLER APPLICABLE TO GASEOUS FUELLED VEHICLES (DEDICATED / BI-FUEL / DUAL FUEL / DEDICATED DUAL FUEL AS APPLICABLE)

The following are the criteria to be complied by the kit supplier / manufacturer for conversion of in-use gaseous fuelled vehicles

- 1.0 The replacement of engine / retro fitment of gas kit shall be type approved by any one of the testing agencies specified in Rule 126 of the Central Motor Vehicle Rules. The responsibility of the type approval and ensuring that the kits manufactured comply with the provisions and installation thereof shall be that of the vehicle / kit manufacturer / supplier as the case may be.
- 2.0 Only the Installer authorized by vehicle / kit manufacturer / supplier shall fit the kit on vehicles. For this purpose, the vehicle / kit manufacturer / supplier shall issue a certificate of authorization to the Installer concerned duly authorizing them to fit the kit on behalf of manufacturer.
- 3.0 Kit installer shall be equipped with the following recommended tools and equipment.
 - a) Two post lift / ramp
 - b) Electric hand drill machine and H.S.S. drill bits
 - c) Tube bender
 - d) Tube cutter
 - e) Deburring tool for tube
 - f) Set of 'D' ring and box spanners
 - g) Set of screw driver (both flat and star)
 - h) Set of allen keys
 - i) H.S.S. hand saw
 - j) Crimping tool for electrical cable termination
 - k) Soap bubble bottle
 - l) Set letter and number punch
 - m) Infrared pollution meter
 - n) Timing gun
 - o) Filler gauge

- p) Measurement tape
- q) Air compressor
- r) Flame proof inspection light
- s) Vernier caliper
- t) Multimeter
- u) Silicon seal / sealant

Firefighting equipment

- a) Dry chemical powder (DCP) type
- b) Minimum two numbers of 5 kg each with ISI mark.
- c) CO₂ type fire extinguisher – minimum 1 number of 5 kg with ISI mark.
- d) Fire buckets – 2 buckets.

4.0 Installer shall have trained technicians having minimum ITI qualification and at least two years of experience in the similar field. Vehicle / kit manufacturer / supplier to impart extensive training to the technicians on gas kit installation.

5.0 Installer to display in the premises, authorization certificate issued by vehicle manufacturer / kit manufacturer / supplier. Also, installer to display details of the facilities available in terms of equipment and trained manpower.

5.1 After obtaining the type approval certification, the vehicle / kit manufacturer / supplier(s) shall authorize the installer to undertake gas conversion, who meets the following requirements.

- i) Name and communication details like address, telephone number, etc. of the installer.
- ii) Business profile
- iii) Qualification
- iv) Experience
- v) Details of technical staff and equipment
- vi) Specification of workshop/land use certificate from appropriate authority.

The vehicle / kit manufacturer or supplier shall submit the above information to the regional transport authorities.

6.0 Installer to carry out conversion / installation as per “Code of Practice for Use of Gaseous fuels in internal combustion engined vehicles (AIS-028 (Rev. 1) (Part A))”

- 7.0 Installer to carry out the inspection, testing, commissioning & garaging / repair of as per AIS-028 (Rev.1) (Part A).
- 9.0 Installer shall issue installation certificate as per Annexure VI of AIS-024 (Rev.1) (Part A), to the vehicle owner, that the conversion kit has been fitted in safe and proper manner, in compliance with “Code of Practice for Use of Gaseous fuels in internal combustion engines (AIS-028 (Rev. 1)(Part A))”
- 9.0 Installer to send a copy of installation certificate as per Annexure VI of AIS-024 (Rev.1) (Part A), and duly filled checklist as per “Appendix A of AIS-028 (Rev.1) (Part A) (for vehicles other than CNG / BIO-CNG / LNG buses) / Annexure VII of AIS-024 (Rev.1) (Part A) (for CNG / BIO-CNG buses) to RTO, who has type approved the Gas conversion kit.
- 10.0 The record of conversion / alteration of vehicles carried out by the kit installer shall be maintained and made available to the authorities such as MORTH / Test Agencies / Transport Authorities as and when demanded.
- 11.0 The vehicle owner shall apply to the concerned registering authority within 14 days of undertaking the alteration, as required under Section 52 of Motor Vehicle Act 1988, for endorsement of particular alteration in registration certificate mentioning place and date of installation and installation certificate number. This shall also be ensured by the kit installer.
- 12.0 The vehicle / kit manufacturer or supplier shall impart training to installer on installation, maintenance and operation of gas system and issue the training certificate to installer after completion of training. The test agency may devise the appropriate training programme as required.
- 13.0 The training shall encompass the following:
 - 13.1 Gas Tank
 - a) Fitments on tank
 - b) Location and ventilation of tanks.
 - c) Construction of compartment and sub-compartment
 - d) Installation of tank
 - e) Shielding
 - 13.2 Gas Fuel Line
 - a) Testing of gas fuel line
 - b) Flexibility
 - c) Installation
 - 13.3 Gas Control Equipment
 - a) Installation of regulator and its functioning

- b) Installation of fuel selection switch and its information
- 13.4 Inspection, Testing and Commissioning of Gas System
 - a) Commissioning
 - b) Leak testing
- 13.5 Garaging and Repair
 - a) Repair operation of gas converted / retrofitted vehicles
 - b) Scrapping
- 13.6 Periodic inspection
- 13.7 CNG / BIO-CNG / LNG Characteristics and Safety Aspects for Handling and Storage
- 14.0 The kit installer shall ensure compliance to the emission norms and Sub-rule 2 of Rule 115, 115AA and the code of practice for the use of gaseous fuel in internal combustion engined vehicles.
- 15.0** Responsibility of the vehicle / kit manufacturer / supplier / installer : The owner / driver shall be instructed in the correct way the gas system and controls function along with a owners operation manual for the gas system outlining the following:
 - 15.1 Basic gas system explanation with a diagram
 - 15.2 Fuel change over switch operation if bi-fuel / Dual fuel system is fitted
 - 15.3 Starting procedure for cold and hot starting
 - 16.0 How the vehicle is refueled
 - 16.1 In the event of backfiring check procedure
 - 16.2 In the event of a gas leak shut off procedure
 - 16.3 Emergence or information contact numbers

ANNEXURE VI

**INSTALLATION CERTIFICATE FOR CONVERTED / OE GASEOUS FUELLED
VEHICLE (DEDICATED / BI-FUEL / DUAL FUEL / DEDICATED DUAL FUEL AS
APPLICABLE) (TO BE FILLED IN BY INSTALLER / OE)**

A. Details of Installer Approval:	
1. Installation Certificate issued by	Name and address of installer / OE
2. Installer Approved By	Name of vehicle manufacturer / kit manufacturer / kit supplier, who has approved the installer
3. Category of vehicle converted as per CVMR, 1989	
4. Approval of the Gas kit	
a) Name of the Test Agency	
b) Approval Certificate No. & Date	
B. Details of Converted Vehicles	
a) Regn. No. & year of manufacture	
b) Chassis and engine No.	
c) Type of Operation (Bi-fuel / Dual fuel / dedicated fuel /Dedicated Dual fuel)	
C. Details of Gas Kit	
1. Cylinders:	
a) No. of Cylinder/s	
b) Type of Cylinder/s	
c) Cylinder No/s.	
d) Make	
e) Water Capacity (litres) and diameter (mm)	
f) Working Pressure (kg/cm ²)	
g) Approval reference of PESO with date	
h) Validity of PESO Certificate	

2. Cylinder Valves	
a) Make	
b) Valve No.	
b.1) Serial no	
b.2) Identification No.	
c) Working Pressure (kg/cm ²)	
d) Approval reference of PESO with date	
3. Refilling Valve :	
a) Make	
b) Type	
c) Identification No.	
4. Fuel Line	
a) High pressure pipe dia. (ID / OD)	
b) Low pressure pipe dia. (ID / OD)	
c) Low pressure pipe Identification No.	
5. Shut Off Valve (Solenoid Valves)	
a) Make	
b) Type	
c) Operation Voltage	
6. Fuel selection switch	
a) Make	
7. Regulator	
a) Make	
b) Type	
c) TAC No.	
8. Gas-Air Mixer/ Injector	
a) Make	
b) Identification No.	

9. Vaporizer/Heat exchanger (for LNG)	
a) Name of manufacturer	
b) Model name/Identification No.	
c) Type	
10. Gas Injector	
a) Make	
b) identification No.	
Note:	
1) This certificate shall be filled and provided to vehicle owner for all converted vehicles for gas operation.	
2) A copy of this certificate along with checklist as per Appendix A of safety document shall be forwarded to RTO from where the approval for kit is obtained.	
Signature & Seal of OE/ Installer	

ANNEXURE VII

CHECKLIST FOR THIRD PARTY CHECKING / INSPECTION OF BUILT UP GASEOUS FUEL OPERATED BUSES (NEW AND CONVERTED / IN-USE AND RETROFITTED) BEFORE REGISTRATION (DEDICATED / BI-FUEL / DUAL FUEL / DEDICATED DUAL FUEL AS APPLICABLE)

This checklist is for third party inspection of fully built CNG / BIO-CNG / LNG buses before registration by RTOs. Reference to relevant clauses of Safety Code of Practice, e.g. AIS-028, and guidelines issued by Central Government from time to time should be made wherever appropriate. It may be noted that Liquefied Natural Gas (LNG) shall be permitted for OE manufactured Vehicles having GVW \geq 3.5 T.

A. Details of CNG / BIO-CNG / LNG Bus							
1.	<table border="1"> <tr> <td>a) Name and address of chassis manufacturer (applicable for new & Converted / Retrofitted in-use)</td> <td></td> </tr> <tr> <td>b) Name and address of retrofitter (applicable for Converted / Retrofitted in-use)</td> <td></td> </tr> <tr> <td>c) Name and address of engine manufacturer (applicable for Converted / Retrofitted in-use)</td> <td></td> </tr> </table>	a) Name and address of chassis manufacturer (applicable for new & Converted / Retrofitted in-use)		b) Name and address of retrofitter (applicable for Converted / Retrofitted in-use)		c) Name and address of engine manufacturer (applicable for Converted / Retrofitted in-use)	
a) Name and address of chassis manufacturer (applicable for new & Converted / Retrofitted in-use)							
b) Name and address of retrofitter (applicable for Converted / Retrofitted in-use)							
c) Name and address of engine manufacturer (applicable for Converted / Retrofitted in-use)							
2.	Name of type approval agency						
3.	Details of type approval certificate						
4.	Name and address of bus body builder						
5.	Name and address of approved inspecting agency at R.T.O.						
6.	Chassis and engine No.						
7.	Year of manufacture						
B. Detail of CNG / BIO-CNG/LNG System							
1.	Checking of Cylinders as per PESO/ vehicle testing agency approvals						
	<ul style="list-style-type: none"> Validity of PESO Certificate 						
	<ul style="list-style-type: none"> Safety checks 						

<p>a. Check for corrosion on any CNG / BIO-CNG/LNG components / mountings of gas circuit</p>	
<p>b. Check whether cylinder is securely mounted within the vehicle and check tightness of nuts and bolts</p>	
<p>c. Check whether minimum 5 mm clearance is kept between cylinders and vehicle body structure</p>	
<p>d. Distance between cylinder valve and bus body extremities shall not be less 200 mm unless valves are protected (as per the details provided by the kit/vehicle manufacturer/kit supplier and duly vetted and approved by test agencies) to minimize the possibility of damage due to collision, overturning / other accident.</p>	
<p>e. Check that the material of the padding / lining provided for inner side of cylinder mounting band (s) is made up of EPDM non-moisture retaining rubber (hardness Shore A 60 min.) and tested as per AIS-066 as approved by the test agency during type approval certification.</p>	
<p>Note:</p>	
<ul style="list-style-type: none"> • In case of doubt, Inspecting Agencies will request the OE vehicle manufacturer/retrofitter to supply the sample of material for padding rubber which has been type approved by the testing agencies. 	
<ul style="list-style-type: none"> • Rubber packing if found damaged during inspection it should be replaced by the new material having revised specification 	
<p>2. Cylinder Valves</p>	
<p>a. Check specific type & model approved by Vehicle testing agency for the vehicle under inspection.</p>	

b. Check for operation	
c. Check for Shield / protection	
d. Check for physical damage to valves	
e. Check for burst disc with fusible plug as approved by PESO (NA for LNG)	
f. Leak test using non corrosive foaming agent(e.g. snoop of M/s Swagelok, collin etc) or Methane leak detector	
3. Refilling Valve	
<ul style="list-style-type: none"> • Safety checks 	
a. Check for dust cap / plug	
b. Check that engine should not start when dust cap / plug is removed or open (NA for LNG)	
<ul style="list-style-type: none"> • Check for proper make & type of interlocking switch as approved by testing agencies. (NA for LNG) 	
<ul style="list-style-type: none"> • Check leakage for non-return valve using non-corrosive foaming agent (i.e. snoop of M/s Swagelok, collin etc.) or Methane leak detector. 	
4. Fuel Line	
<ul style="list-style-type: none"> • Safety checks 	
a. Check for corrosion, damage on CNG / BIO-CNG / LNG fuel line	
(In case of PVC sleeved fuel line, corrosion shall be inspected at the ends, wherever it is exposed. Also inspect for any damage to the sleeving. Sleeve should be firmly gripped to the CNG / BIO-CNG / LNG fuel line)	
b. Check whether fuel line is securely mounted	

<p>c. Check for deformation of U and Pigtail bends provided in high pressure piping for flexibility as per approved layout</p>	
<p>d. Distance between fuel line and exhaust pipe / shield shall not be less than 75 mm and the fuel line should also be properly clamped and routed so as not to touch the engine block.</p>	
<p>e. Check whether effective protection is provided, as per approved layout, to prevent the possibility of damage due to loose objects from road.</p>	
<p>f. Check the distance between any two clips which shall not be more than 600mm</p>	
<p>g. Leak test using non-corrosive foaming agent(i.e. snoop of M/s Swagelok, collin etc.) or methane leak detector</p>	
<p>5. Shut Off Valve (Solenoid Valve(s)) wherever separately provided</p>	
<ul style="list-style-type: none"> • Safety checks 	
<p>a. Verify the following as per type approval specification</p>	
<p>➤ Make</p>	
<p>➤ Type (if applicable)</p>	
<p>➤ Identification No.</p>	
<p>b. Check whether shut off valve is securely mounted</p>	
<p>c. Check operation for “Close & Open” as required</p>	
<p>d. Leak test using non-corrosive foaming agent (i.e. snoop of M/s Swagelok, Collin etc.) or methane leak detector</p>	

6. Regulator	
• Safety checks	
a. Verify the following as per type approval specification	
➤ Make	
➤ Type (if applicable)	
➤ Identification No.	
b. Check whether regulator is securely mounted	
c. Leak test using non-corrosive foaming agent(i.e. snoop of M/s Swagelok, collin etc.) or methane leak detector	
7. Heat exchanger Vaporizer(LNG)	
• Safety checks	
a. Verify the following as per type approval specification	
➤ Make	
➤ Type (if applicable)	
➤ Identification No.	
b. Check whether regulator is securely mounted	
c. Leak test using non-corrosive foaming agent(i.e. snoop of M/s Swagelok, collin etc.) or methane leak detector	
8. Gas-Air Mixer	
9. Electrical wiring: Safety checks	
9.1 For OE & Converted / Retrofitted In-Use Vehicles	

<p>a. Check whether that current limiting device (fuse) is fitted as per manufacturer specifications and make</p>	
<p>b. Terminals are insulated to prevent shorting</p>	
<p>c. Wiring are taped and clipped with loom & mounted securely.</p>	
<p>d. Battery shall be securely mounted and battery terminal shall be locked properly by means of suitable nut & bolt with washers.</p>	
<p>e. Check installation of battery cut-off switch as per chassis manufacturer's recommendations. Location of Battery cut-off switch should be within the reach of driver in seating posture in driving seat.</p>	
<p>f. Check routing of high tension cable to avoid accidental earthing and to be placed away from any heat source - as per chassis manufacturer's recommendations / layout</p>	
<p>g. Check for proper make of high tension cable as per chassis manufacturer's recommendation as well as check for tight fitment of its terminal to the spark-plug</p>	
<p>9.2 For OE Vehicles</p>	
<p>a. Check wiring harness layout under the floor and in the engine compartment to be in accordance with chassis manufacturer's layout / specifications / approval</p>	
<p>b. Check wiring harness in cabin and passenger compartment to be as per chassis manufacturer's guidelines / approval</p>	
<p>c. Cable harness has to be as per the recommendations of OE chassis/ vehicle manufacturers</p>	

9.3 For Converted / Retrofitted In-Use Vehicles	
a. Check wiring harness layout under the floor / cabin and passenger compartment for proper sleeving and routing in order to avoid accidental sparking.	
10. Service shut-off valve:	
Safety checks	
a. Make & type	
b. Check operation	
c. Check whether service shut off valve is securely mounted	
d. Leak test using non-corrosive foaming agent (i.e. snoop of M/s Swagelok, collin etc.) or methane leak detector	
11. Gas Filter:	
a. Check whether Gaseous fuel filter is securely mounted	
b. Leak test using non-corrosive foaming agent (i.e. snoop of M/s Swagelok, collin etc.) or methane leak detector	
12. Gas Pressure Gauge / Content Gauge in case of LNG :	
a. Make & type	
b. Check whether gas pressure indicator / LNG content gauge is securely mounted	
c. Leak test using non-corrosive foaming agent (i.e. snoop of M/s Swagelok, collin etc.) or methane leak detector	
13. Compliance Plate:	

13.1 Installation Check						
Check for following	Details for no. of Cylinders					
	1	2	3	4
a. Cylinder identification No.						
b. Date of last testing and the name of certifying agency						
c. Water capacity (ltr)						
d. Next due date of testing						
e. Date of Installation						
f. Water capacity (ltr) of total installation						
g. Vehicle registration/ identification No. (to be furnished after registration)						
h. Seal /Identification of the checking /inspection agency(who carries out the 3 rd party inspection)						
i. Check whether compliance plate is installed near filling connection & be clearly visible to the filling agency						
14. Identification label in front and rear:						
Located on left side of the front and rear safety glass and shall ensure visibility from front and rear sides						
15. Catalytic Convertor(whenever it is part of kit)						
a. Verify make and type of the catalytic converter as per the vehicle manufacturer's specification and / as given in the type approval certificate as the case may be.						
16. Low pressure hose						
a. Verify make and type of the low pressure hose as per the Type Approval specification.						
b. Check for kinks, damage or abrasion to the cover						
(Note: In case of doubt, Inspecting Agencies will request the OE vehicle manufacturer/retrofitter to supply the sample of material for low pressure hose which has been type approved by the testing agencies.)						
17. Following additional points are to be complied at the time of registration / before endorsement by the competent authority (after conversion) of gaseous fueled vehicle for enhancement of safety of vehicle.						
Fire retardant material conforms to FMVSS 302 for seat / upholstery/roof & side lining & IS: 2465 for wiring cables shall be used. The OE / Vehicle manufacturer / retrofitter shall submit declaration with respect to design, manufacturing processes and material conforming the use of fire retardant materials.						

Notes:
For OE fully built vehicles, type approval is subjected to meeting the requirements as mentioned above. In case of type approval of drive-away chassis, declaration from chassis manufacturer for above tests shall be verified by inspection agency.
In case of doubt, Inspecting Agencies will request the OE vehicle manufacturer / retrofitter to supply the sample of material for cables / Seat / upholstery / roof & side lining which has been type approved by the testing agencies.
a. One number each of dry powder type fire extinguishers (2 kg) shall be provided in driver's and passenger's compartment. For servicing of gaseous fuelled vehicle proper instructions, detail operational & service manual with DO's & DON'Ts shall be provided by chassis manufacturer and body builder/retrofitter. Vehicle / chassis manufacturer / retrofitter should devise training module and impart training to drivers and technicians for safe operation of gas system.
b. Check for First-Aid kit as per CMVR.
c. Distance between the exhaust line, muffler and fuel line shall be a minimum of 75 mm. If not a radiant heat shield of 2mm thickness shall be welded in between
d. Safety plates / shield below the pipe joints shall be welded and proper inspection windows shall be provided near the cylinder joints.
e. Minimum two copies of safety instructions shall be displayed in passenger's compartment.
f. Check for proper venting provided by louvers / holes / mesh on the side skirt so that in case of any leakage the entrapped gas under the floor escapes to the atmosphere.
g. The bus body builder/retrofitter to provide at least two (total minimum area of 450 sq. mm) vent pipes connecting the under floor of the bus to the rooftop for gas to vent out in case of leakage. The vent pipes to be located close to the cylinder valves cluster as per recommendations of chassis manufacturer. Construction should be such that leakage into passenger compartment is avoided.
h. Any other safety recommendations provided or advised by the chassis manufacturers to be complied with.
Note: The instructions issued by OE manufacturer/retrofitter for third party evaluation, in their instruction manual, shall contain all the necessary details on the methodology & the procedure for carrying out these checks.
Signature & Seal with date

ANNEXURE VIII

**CHECKLIST FOR PREVENTIVE MAINTENANCE OF IN-USE
GASEOUS FUELLED VEHICLES (DEDICATED / BI-FUEL / DUAL FUEL
/ DEDICATED DUAL FUEL AS APPLICABLE)**

This checklist is A GUIDE for preventive maintenance of fully built in-use gaseous fuelled vehicles. Preventive maintenance shall be carried out by authorized installer at authorized workshop only, as prescribed in CMVR. Reference to relevant clauses of Safety Code of Practice, e.g. AIS-028, and guidelines issued by Central Government from time to time should be made wherever appropriate.

A. Details of Gaseous Fuelled Vehicle		
1. Name and address of owner of vehicle		
2. (a) Type of vehicle (as per CMVR 1989)		
(b) Model		
3. (a) Name of OE manufacturer		
(b) Name of kit retrofitting center		
4. Name and address of approved inspecting agency at R.T.O.		
5. Chassis No., Engine No. and Vehicle Registration No.		
6. (a) Year of manufacture of vehicle		
(b) Date of endorsement of Gaseous fuel kit in RCTC book		
B. Detail of Gaseous fuel kit System		
1. Checking of Cylinders as per PESO/ vehicle testing agency approvals	Approved Specification at the time of Type Approval	Remarks of Inspection Authority
a) No. of Cylinders		
b) Approval from PESO		
c) Validity of PESO Certificate		Check or Re-test cylinders as per Gas Cylinder Rules, 2016 as amended from time to time

Other checks		Periodicity of checks
a) Check for corrosion on any gas kit components / mountings of gas cylinders		Weekly
b) Ensure cylinder is securely mounted within the vehicle; check tightness of nuts and bolts		Weekly
c) Ensure minimum 5 mm clearance is kept between cylinders and vehicle body structure		Weekly
d) Distance between cylinder valve and bus body extremities shall not be less than 200 mm.		Weekly
2. Cylinder Valves		
a) Approval from PESO		Periodicity of checks
b) Check for Shield / protection and physical damage to valves		Weekly
c) Leak test using non-corrosive foaming agent or Methane leak detector		Daily
3. Refilling Valve / Filling Receptacle		Periodicity of checks
a) Check for dust cap / plug		Weekly
b) Check that engine should not start when dust cap / plug is removed or open (NA LNG)		Weekly
c) Check leakage for non-return valve using non corrosive foaming agent or Methane leak detector		Daily
4. Fuel Line		Periodicity of checks
a) Check for corrosion on gas fuel line		Weekly
b) Ensure fuel line is securely mounted		Weekly
c) Check for deformation of U & pigtail bends		Weekly

d) Check hose for twists, kinks and damage or abrasions to the cover, which expose the wire/ fiber and shall be condemned on detection of any one of these defects.		Weekly
e) During servicing hose shall be replaced by new hose; after removal from vehicle		Weekly
f) Check distance between fuel line and exhaust heat source is more than 75 mm.		Weekly
g) Leak test using non-corrosive foaming agent or methane leak detector		Daily
5. Shut Off Valve (Solenoid Valve(s)) wherever separately provided		Periodicity of checks
a) Ensure shut off valve is securely mounted		Weekly
b) Check operation for “Close & Open” as required and replace if found damaged		Weekly
c) Leak test using non-corrosive foaming agent or methane leak detector		Daily
6. Regulator / Heat exchanger Vaporizer (LNG)		Periodicity of checks
a) Ensure regulator / Heat exchanger Vaporizer is securely mounted		Weekly
b) Check for shield or protection		Weekly
c) Replace regulator diaphragms, hot water hoses, seals in accordance with manufacturer's recommendation		Weekly
d) Leak test using non-corrosive foaming agent or methane leak detector		Daily
7. Gas-Air Mixer		Periodicity of checks
a) Ensure gas-air mixer is securely mounted		Weekly
b) Leak test using non-corrosive foaming agent or methane leak detector		Daily
8. Electrical wiring		Periodicity of checks

a) Ensure that current limiting device (fuse) is fitted as per manufacturer's specs and make		Weekly
b) Check any loose or open or broken wiring harness in engine compartment, under chassis and driver's cabin and take corrective action.		Monthly
c) Cable harness has to be as recommended / approved by the OE vehicle manufacturers / retrofitters)		Monthly
d) Battery terminal has to have a positive locking		Monthly
e) Check operation of battery cut-off switch as per manufacturer's recommendations		Monthly
f) Check for proper tight fitness and clamping of terminal fitting. Replace high tension cables as per manufacturer's recommendation.		Monthly
9. Service shut-off valve		Periodicity of checks
a) Check operation, replace in case inoperative		Weekly
b) Ensure service shut off valve is securely mounted		Weekly
c) Leak test using non-corrosive foaming agent or methane leak detector		Daily
10. Gas Filter		Periodicity of checks
a) Ensure gas filter is securely mounted		Weekly
b) Leak test using non-corrosive foaming agent or methane leak detector		Daily
11. Gas Pressure indicator / content Gauge / sensor		Periodicity of checks
a) Ensure gas pressure indicator / Pressure Gauge is securely mounted		Weekly
b) Check for operation, replace if it is inoperative		Weekly

<p>c) Leak test using non-corrosive foaming agent or methane leak detector</p>		<p>Daily</p>
<p>12. Following additional points need to be complied for carrying out preventive maintenance every month, unless and otherwise specified.</p>		
<p>a) Replace spark plugs and high tension cables as per manufacturer's recommendations.</p>		
<p>b) Check ignition timing by using timing light at engine idle speed (and other speeds as specified) and correct, if required.</p>		
<p>c) Check function of O₂ sensor output (milli-volt variation using multimeter) as per manufacturer's recommendations.</p>		
<p>d) Check for any exhaust gas leak before the catalytic converter and correct, if necessary.</p>		
<p>e) Replace catalytic converter as per manufacturer's recommendations.</p>		
<p>f) One number each type of dry powder type fire extinguisher (2 kg) shall be provided in driver and passenger compartment.</p>		
<p>g) Buses should be properly maintained and checked every day before starting and bringing on road.</p>		
<p>h) Distance between the exhaust line, muffler and fuel line shall be a minimum of 75 mm. If not a radiant heat shield of 2mm thickness shall be welded in between.</p>		
<p>i) Safety plates / shield below the pipe joints shall be welded and proper inspection windows shall be provided near the cylinder joints.</p>		
<p>j) Check for First-Aid kit as per CMVR</p>		
<p>k) Minimum two copies of safety instructions shall be displayed in passenger compartment.</p>		
<p>l) Any other preventive safety recommendations provided or advised by chassis manufacturers / retrofitters to be complied with.</p>		
<p>Note: The instructions issued by OE manufacturer/retrofitter for preventive maintenance, in their instruction manual, shall contain all the necessary details on the methodology & the procedure for carrying out these checks.</p>		
<p style="text-align: right;">Signature & Seal with Date</p>		

ANNEXURE IX

CHECKLIST FOR THIRD PARTY CHECKING / INSPECTION OF GASEOUS FUEL VEHICLES (OTHER THAN GASEOUS FUEL BUSES) (NEW AND CONVERTED / IN-USE AND RETROFITTED) BEFORE REGISTRATION (DEDICATED / BI-FUEL / DUAL FUEL / DEDICATED DUAL FUEL AS APPLICABLE)

This checklist is for third party inspection of gaseous fuelled vehicles before registration by RTOs. Reference to relevant clauses of Safety Code of Practice in this standard. AIS-028 (Rev.1) (Part A), and guidelines issued by Central Government from time to time should be incorporated, wherever appropriate.

1. Details of Gaseous fuelled vehicle	
1(a) Name and address of OE Vehicle manufacturer	
1(b) Name of the Retrofitter holding the type approval certificate	
1(c) Name of the authorized kit installer duly authorized by the original retrofitter	
1(d) Fuel system (Dedicated, Bi-Fuel, Dual Fuel & Dedicated Dual Fuel)	
1(e) Type of DUAL- fuel system (Type 1A / 1B / 2A / 2B / 3B)	
2. Name of type approval agency	
3. Reference number of type approval certificate	
3.1 Validity	
3.1.1 Gasoline Vehicles(Converted / Retrofitted in-use)	
a. cc of base model tested	
b. Flexibility available for conversion +/- 25% of the base model	
c. Period of validity, i.e. from ---- to ----	
3.1.2 Diesel Vehicles(Converted / Retrofitted in-use)	
a) Type and make of model	
b) Year of manufacture	
c) Period of Validity, i.e. from --- to ---	
3.1.3 In the case of OE	

a) Validity will be for the base model and its variants given in the type approval certificate	
b) Period from --- to -- (as given in the type approval certificate)	
4. Name and address of approved inspecting agency at R.T.O.	
5. a) Vehicle Registration No: (if applicable)	
b) Vehicle type & model	
6. Chassis and engine No.	
• Original as per RCTC	
or	
• New in case of replacement of engine	
7. Year of manufacture	
a) Chassis in case of drive-away chassis	
b) Fully built up vehicle	
c) Month & year of conversion	
8. Detail of gas fuel System/kit	
8.1 Checking of Cylinders as per PESO/ vehicle testing agency approvals	
Validity of PESO Certificate	
• Safety checks	
a) Check for corrosion on any Gas kit components / mountings of gas circuit	
b) Check whether cylinder is securely mounted within the vehicle and check tightness of nuts and bolts	
c) Check whether minimum 5 mm clearance is kept between cylinder and vehicle body structure and also in between the cylinders, if applicable.	
d) Distance between cylinder valve and vehicle body extremities shall not be less 200 mm unless valves are protected (as per the details provided by the kit/vehicle manufacturer/kit supplier to minimize the possibility of damage due to collision, overturning/ other accident.	
e) Check for reinforcement if cylinder is mounted on floor of the vehicle (minimum dimension of reinforcement thickness & surface area shall not be less than 2.5 mm & 3600 mm ² respectively). The reinforcement shall be provided on the top & bottom of the floor.	

<p>f) Check that the material of the padding / lining provided for inner side of cylinder mounting band(s) is made up of EPDM non-moisture retaining rubber and tested as per AIS-066 as approved by the test agency during type approval certification.</p>	
<p>Notes:</p>	
<ul style="list-style-type: none"> • In case of doubt, Inspecting Agencies will request the OE vehicle manufacturer/retrofitter to supply the sample of material for padding rubber which has been type approved by the testing agencies. 	
<ul style="list-style-type: none"> • Rubber packing if found damaged during inspection it should be replaced by the new material having specification as approved. 	
<p>2. Cylinder Valves</p>	
a) Check specific type & model approved by testing agency for the vehicle under inspection.	
b) Check for operation	
c) Check for physical damage/distortion to valves	
d) Check for Shield / protection	
e) Check for burst disc with fusible plug as approved by PESO (NA for LNG)	
f) Check for the vent pipe outlet routing away from exhaust in case of cylinder fitting in the enclosed compartment.	
g) Leak test using non-corrosive foaming agent(i.e. snoop of M/s Swagelok, collin etc.) or methane leak detector	
<p>3. Refilling Valve</p>	
<p>Safety checks -</p>	
a) Check for dust cap / plug	
b) Check that engine should not start when dust cap / plug is removed or open (NA for LNG)	
c) Check for proper make & type of interlocking switch as approved by testing agencies. (NA for LNG)	
d) Check leakage for non-return valve using non-corrosive foaming agent(i.e. snoop of M/s Swagelok, collin etc.) or Methane leak detector	
<p>4. Fuel Line</p>	
<p>Safety checks</p>	
a) Check for corrosion, damage of gas fuel line	

b) (In case of PVC sleeved fuel line, corrosion shall be inspected at the ends, wherever it is exposed. Also inspect for any damage to the sleeving. Sleeve should be firmly gripped to the gas fuel line)	
c) Check whether fuel line is securely mounted	
d) Check for U and Pigtail bends provided in high pressure piping for flexibility as per approved layout	
e) Check whether effective protection is provided, as per approved layout, to prevent the possibility of damage due to loose objects from road.	
f) Distance between fuel line and exhaust pipe / shield shall not be less than 75 mm and the fuel line should also be properly clamped and routed so as not to touch the engine block.	
g) Check the distance between any two clips which shall not be more than 600 mm (500 mm & 300 mm in case of 3/2 wheeler respectively).	
h) Leak test using non-corrosive foaming agent(i.e. snoop of M/s Swagelok, collin etc.) or methane leak detector.	
5. Shut Off Valve (Solenoid Valve(s)) wherever separately provided)	
a) Safety checks <ul style="list-style-type: none"> • Verify the following as per type approval specification 	
b) Make	
c) Type (if applicable)	
d) Identification No.	
e) Check whether shut off valve is securely mounted	
f) Check operation for “Close & Open” as required	
g) Leak test using non-corrosive foaming agent (i.e. snoop of M/s Swagelok, collin etc.) or methane leak detector	
6. Regulator	
• Safety checks	
a) Verify the following as per type approval specification	

<ul style="list-style-type: none"> • Make 	
<ul style="list-style-type: none"> • Type(if applicable) 	
<ul style="list-style-type: none"> • Identification No 	
b) Check whether regulator is securely mounted	
c) Leak test using non-corrosive foaming agent (i.e. snoop of M/s Swagelok, collin etc.) or methane leak detector	
7. Heat exchanger Vaporizer (LNG)	
<ul style="list-style-type: none"> • Safety checks 	
a) Verify the following as per type approval specification	
<ul style="list-style-type: none"> ➤ Make ➤ Type (if applicable) ➤ Identification No. 	
b) Check whether regulator is securely mounted	
c) Leak test using non-corrosive foaming agent(i.e. snoop of M/s Swagelok, collin etc.) or methane leak detector	
8. Gas-Air Mixer	
<ul style="list-style-type: none"> • Safety checks 	
a) Verify the following as per type approval specification	
<ul style="list-style-type: none"> • Make 	
<ul style="list-style-type: none"> • Type(if applicable) 	
<ul style="list-style-type: none"> • Identification No 	
b) Check whether gas-air mixer is securely mounted	
c) Leak test using non-corrosive foaming agent (i.e. snoop of M/s Swagelok, Collin etc.) or methane leak detector	
9. Electrical wiring: Safety checks	

9.1 For OE & Converted / Retrofitted In-Use Vehicles	
a) Check whether that current limiting device (fuse) is fitted as per manufacturer specifications and make.	
b) Terminals are insulated to prevent shorting.	
c) Wiring are taped and clipped with loom & mounted securely.	
d) Battery shall be securely mounted and battery terminal shall be locked properly by means of suitable nut & bolt with washers.	
e) Check installation of battery cut-off switch as per vehicle / chassis manufacturer's recommendations (if applicable). Location of Battery cut-off switch should be within the reach of driver in seating posture in driving seat.	
f) Check routing of high tension cable to avoid accidental earthing and to be placed away from any heat source – as per Vehicle / chassis manufacturer's recommendations / layout or as approved by Test Agency.	
g) Check for proper make of high tension cable connected to Spark Plug as per Vehicle / chassis manufacturer's recommendation. Check for tight fitment of its terminal to the spark-plug	
9.2 FOR OE	
a) Check wiring harness layout under the floor and in the engine compartment to be in accordance with Type Approval layout / specifications / approval	
b) Check wiring harness in cabin and passenger compartment to be as per approval	
9.3 FOR CONVERTED / RETROFITTED IN-USE VEHICLES	
a) Check wiring harness layout under the floor / cabin and passenger compartment for proper sleeving and routing in order to avoid accidental sparking.	
10. SERVICE SHUT-OFF VALVE	
• Safety checks	
a) Make & type	

b) Check operation	
c) Check whether service shut off valve is securely mounted	
d) Leak test using non-corrosive foaming agent (i.e. snoop of M/s Swagelok, collin etc.) or methane leak detector	
11. Gas Filter: (wherever separately provided)	
a) Check whether gas filter is securely mounted	
a) Leak test using non-corrosive foaming agent (i.e. snoop of M/s Swagelok, collin etc.) or methane leak detector	
12. Gas Pressure Gauge	
Content gauge in case of LNG :	
a) Make & type	
b) Check whether gas pressure indicator is securely mounted. Check whether LNG Content gauge is securely mounted	
c) Leak test using non-corrosive foaming agent (i.e. snoop of M/s Swagelok, collin etc.) or methane leak detector	

13. Compliance Plate:

- Installation Check

Check for following	Details for no. of Cylinders					
	1	2	3	4
a) Cylinder identification No.						
b) Date of last testing and the name of certifying agency						
c) Water capacity (ltr)						
d) Next due date of testing						
e) Water capacity (ltr) of total installation						
f) Vehicle registration / identification No. (to be furnished after registration)						
g) Seal / Identification of the checking / inspection agency (who carries out the 3 rd party inspection)						
h) Check whether compliance plate is installed near filling connection & be clearly visible to the filling agency						

14. Identification label in front and rear:

- a) Located on left side of the front and rear safety glass and shall ensure visibility from front and rear sides

15. Compartment / Sub-compartment / Gas tight housing(for internally mounted cylinder/s)

- a) Check whether Compartment / Sub-compartment / Gas tight housing is in good condition i.e. shall not show any crack/damage.
- b) Check whether it is firmly clamped to the conduit/vent hose/ducting

16. Conduits / ducting / vent hose(for internally mounted cylinder/s)

a) Check whether Conduits/ducting is in good condition i.e. shall not show any crack/damage	
17. Petrol Shut Off Valve (Solenoid) (if applicable i.e. Gasoline injection vehicle PESOs not require such solenoid valve)	
a) Check operation	
b) Check whether Petrol shut off valve is securely mounted	
c) Leak test (visual inspection)	
d) Verify the make & type as per the Type Approval specification.	
18. Fuel selection switch	
a) Check operation	
19. Catalytic Converter(whenever it is part of kit)	
a) Verify make and type of the catalytic converter as per the vehicle manufacturer's specification and / as given in the type approval certificate as the case may be.	
20. Low pressure hose	
a) Verify make and type of the low pressure hose as per the Type Approval specification.	
b) Check for kinks, damage or abrasion to the cover	
(Note: In case of doubt, Inspecting Agencies will request the OE vehicle manufacturer/retrofitter to supply the sample of material for low pressure hose which has been type approved by the testing agencies.)	
21. Following additional points are to be complied at the time of registration/before endorsement by the competent authority (after conversion) of gaseous fuelled vehicle for enhancement of safety of vehicle.	
a. Fire retardant material conforming to FMVSS 302 for seat/upholstery/roof & side lining & IS : 2465 for wiring cables shall be used. The OE / Vehicle manufacturer/retrofitter shall	

<p>submit declaration with respect to design, manufacturing processes and material conforming the use of fire retardant materials.</p>	
<p>Notes:</p>	
<ul style="list-style-type: none"> • For OE fully built vehicles, type approval is subjected to meeting the requirements as mentioned above. In case of type approval of drive-away chassis, declaration from chassis manufacturer for above tests shall be verified by inspection agency. 	
<ul style="list-style-type: none"> • In case of doubt, Inspecting Agencies will request the OE vehicle manufacturer/retrofitter to supply the sample of material for cables / Seat / upholstery / roof & side lining which has been type approved by the testing agencies. 	
<p>b) (i) One number each of dry chemical powder type / CO₂ type fire extinguisher (1kg), for 4 wheeler (LCV etc.) only, shall be provided in driver's and passenger's compartment.</p>	
<p>(ii) One number of dry chemical powder type / CO₂ type fire extinguisher of 1 kg. shall be provided in L7, 3 wheeled and M1 category of vehicles such that it shall be easily accessible to all the occupants.</p>	
<p>c) For servicing of gaseous fuelled vehicle proper instructions, detailed operational & service manual with Dos & DON'Ts shall be provided by kit/vehicle manufacturer's. Vehicle / kit manufacturer/ kit supplier should devise training module and impart training to drivers and technicians for safe operation of gaseous fuel system.</p>	
<p>d) Check for First-Aid kit as per CMVR.</p>	
<p>e) Safety plates / shield below the pipe joints shall be welded and proper inspection windows shall be provided near the cylinder joints.</p>	

<p>f) Minimum one copy of safety instructions shall be displayed in passenger's compartment.</p>	
<p>g) Check the following for the vehicles other than M1 category; fitted with multi cylinders of gas not incorporating the independent venting system.</p>	
<ul style="list-style-type: none"> • Check for proper venting provided by louvers / holes / mesh on the side skirt so that in case of any leakage the entrapped gas under the floor escapes to the atmosphere 	
<ul style="list-style-type: none"> • The Vehicle/kit manufacturer / kit supplier to provide at least two (total minimum area of 450 sq. mm) vent pipes connecting the under floor of the vehicle to the rooftop for gas to vent out in case of leakage. The vent pipes to be located close to the cylinder valves cluster as per recommendations of chassis manufacturer. Construction should be such that leakage into passenger compartment is avoided 	
<p>h) Any other safety recommendations provided or advised by the Vehicle / kit manufacturer / kit supplier to be complied with.</p>	
<p>Note: The instructions issued by OE manufacturer/retrofitter for third party evaluation, in their instruction manual, shall contain all the necessary details on the methodology & the procedure for carrying out these checks.</p>	
<p>Signature & Seal with date</p>	

ANNEXURE X

**TESTS TO BE CARRIED OUT BY TEST AGENCY ON GASEOUS FUEL
VEHICLES (DEDICATED / BI-FUEL / DUAL FUEL / DEDICATED DUAL
FUEL AS APPLICABLE)**

ANNEXURE X-A:

**TESTS TO BE CARRIED OUT BY TEST AGENCY FOR GAS KIT
FITMENT BY OE MANUFACTURER ON NEW VEHICLE**

Performance test to be carried out by Test Agency	For converted Gasoline vehicles	For OE Dedicated Gaseous fuelled vehicles	For OE Dedicated Dual fuel /dual fuel; CNG / BIO CNG / LNG vehicles
Mass emission test	√	√	√
Engine performance test	√	√	√
Constant speed fuel consumption test as applicable	√	√	√*
Gradeability test	NA	√	√
EMI/EMC test as notified by Government of India from Time to time	√	√	√
Range test of at least 250 km for buses	NA	√	√
Cooling performance test as per IS 14557	NA	√	√
Any other tests as made applicable by Government of India from time to time	√	√	√

ANNEXURE X-B
TESTS TO BE CARRIED OUT BY TEST AGENCY
(FOR RETROFITMENT OF IN-USE VEHICLE)

Performance Tests to be carried out by Test Agency, as per applicable CMVR prevailing in the year of manufacture of vehicle model:	For In-use Gasoline Vehicles	For Retro fitment / Modification of In-use Diesel Vehicles	For retrofitted Dual Fuel Vehicles
Mass emission test	√	√	√
Engine performance test		√	√
Constant speed fuel consumption test as applicable	√	√	√*
Gradeability test	NA	√	√
EMI/EMC test as notified by Government of India from Time to time	√	√	√
Range test of atleast 250 km for buses	NA	√	√
Cooling performance test as per IS 14557	NA	√	√
Any other tests as made applicable by Government of India from time to time	√	√	√

* Test need to be done on Dual fuel mode (Consumption of both Diesel and gas fuel to be measured)

NA- Not Applicable

ANNEXURE X-C
TESTS TO BE CARRIED OUT BY TEST AGENCY
(FOR REPLACEMENT OF IN-USE DIESEL ENGINE BY
DEDICATED NEW GAS ENGINE)

Performance test to be carried out by Test Agency	For Replacement of In-use Diesel Engine by New gas Fuel Engine
Mass emission test	√
Engine performance test	√
Constant speed fuel consumption test as applicable	√*
Gradeability test	√
EMI/EMC test as notified by Government of India from Time to time	√
Range test of atleast 250 km for buses	√
Cooling performance test as per IS 14557	√
Any other tests as made applicable by Government of India from time to time	√

* Test need to be done on dual fuel mode (Consumption of both Diesel and gas fuel to be measured)

NA- Not Applicable

Code of Practice for use of Gaseous Fuels in Internal Combustion Engine Vehicles**1.0 GENERAL**

This code of practice may be called as "Code of Practice for Use of gas fuel in Internal Combustion Engined Vehicles".

1.1 SCOPE

1.1.1 This code of practice shall apply to the design, construction, installation, operation, maintenance, inspection, testing and fueling of compressed natural gas systems when used as either Dedicated / Bi-fuel / Dual fuel / Dedicated dual fuel) for internal combustion engines. In general, the Standard is directed towards vehicle installations.

1.1.2 It is not intended to cover the areas where major structural modifications are to be carried out to the vehicle (major structural modifications are those not defined in 1.1.4). Prior to commencement of such work guidance should be sought from the vehicle manufacturer.

1.1.3 Reserved

1.1.4 Any alterations or modification to any vehicle to install equipment shall be carried out in accordance with sound engineering practices and in compliance with Central Motor Vehicles Act 1988 and Central Motor Vehicles Rule, 1989 and their superseding amendment and notification issued thereafter. The following aspects shall be taken into consideration during alteration or modification:

Where modifications are made to:

- (a) Suspension: mounting locations, geometry, ground clearance adjustment, axles and sub-axles, or steering mechanism
- (b) Original fuel storage: the fuel tank assembly, fuel tank mounting, venting or filler assemblies.

Note – In some instances the fuel tank constitutes a structural member of the vehicle.

- (c) Vehicle structure: Holes greater than 13 mm shall not be located within 40 mm of the edge of a panel, welded joint or direct load bearing point (such as a belt anchor). The only holes permitted greater than 13 mm diameter are of the installation of the filling valve or for venting purposes.

- (d) Braking system including the hand brake and components.

In this aspect, design guidelines supplied by vehicle manufacturers, vehicle safety standards of Indian or relevant standard, wherever applicable shall be referred.

Note- In case of the retro fitment, where modification types (a) (b) (c) and (d) are carried out to heavy motor vehicles these will require prior design approval from vehicle manufacturer.

1.2 Approved equipment

Only equipment and systems approved by the relevant Test Agency as listed under CMV Rule no 126 shall be used.

1.2.1 This Standard is not intended to cover gas fuel systems for the propulsion of marine craft.

1.3 Definitions

For the purpose of this Standard, the following definitions shall apply:

1.3.1 **Approved or approval.** Approved by or approval of the Statutory Authority.

1.3.2 **Authorized person.** A person, normally an automotive workshop person, authorised by the vehicle manufacturer or the conversion kit ‘manufacturer / kit supplier specially trained for installation, maintenance and periodic inspection of motor vehicle converted for Dedicated / Bi-fuel / Dual fuel / Dedicated Dual Fuel of internal combustion engines.

1.3.3 **“Automatic fuel shut-off valve”** means a device such as solenoid valve for shutting off the fuel supply unless certain essential conditions exist.

1.3.4 **“Compressed natural gas (CNG / BIO CNG)”** means a compressed gaseous fuel composed predominantly of Methane (CH₄) shall be used as specified by the Government of India from time to time.

1.3.5 **“Bio-CNG (biomethane)”** shall meet the requirements of IS 16087 -2016 and shall be stored and transported through cylinders conforming to IS 7285(Part 2) and for automotive use, it shall be filled in cylinders conforming to IS 15490.

1.3.6 **“Liquefied Natural Gas (LNG)”** means a Natural gas that has been cooled to -259 degrees Fahrenheit (-161 degrees Celsius) and at which point it is condensed into a liquid which is colorless, odorless, non-corrosive and non-toxic. Characterized as a cryogenic liquid. Fuel quality for Automotive use shall meet the requirements of BIS specification as notified from time to time by MoPNG, Govt. of India.

1.3.7 **“Cylinder”** means a pressure vessel for storage of gaseous fuel for use as fuel for an internal combustion engine, approved / endorsed by Department of Explosives under Gas Cylinder Rules, 2016 as amended from time to time.

LNG cylinder shall meet the requirements of Gas Cylinder Rules 2016 or equivalent standard or as approved / endorsed by PESO under Gas Cylinder Rules, 2016 as amended from time to time.

- 1.3.8 **“Cylinder valve”** means a manually controlled shut-off valve fitted on the cylinder which can open or shut off the gaseous fuel supply and which incorporates a burst disc (NA for LNG) backed with a fusible material, approved / endorsed by Department of Explosives under Gas Cylinder Rules, as amended from time to time.
- LNG cylinder valve(s) shall meet the requirements of Gas Cylinder Rules 2016 or as approved / endorsed by Department of Explosives under Gas Cylinder Rules 2016 as amended from time to time.
- 1.3.9 **“Dedicated Engine”** (for diesel engine conversion only) means an engine operating on gaseous fuel only.
- 1.3.10 **“Downstream”** means a direction in which the stream flows.
- 1.3.11 **“Excess-flow valve”** A valve normally in the open position which closes automatically in the direction of flow for which it is designed, when a predetermined flow limit is exceeded.
- 1.3.12 **“Excess pressure device / Pressure relief valve”** An automatic pressure relieving device.
- 1.3.13 **“Gas-air mixer”** means a device for introducing gaseous fuel to the induction air of the engine.
- 1.3.14 **“Heavy motor vehicle”** means a vehicle for either goods or passenger services as defined under the Central Motor Vehicle Rules (CMVR) as applicable.
- 1.3.15 **“Non-return valve / Check valve”** means a valve, which permits fuel flow in one direction only.
- 1.3.16 **“Pressure”** Pressure refers to gauge pressure.
- 1.3.17 **“Pressure indicator”** means a device to indicate the pressure of gas in the cylinder.
- 1.3.18 **“Regulator”** means a device which reduces fuel pressure to a level appropriate for the delivery to the gas-air mixer.
- 1.3.19 **“Service fuel line”** The fuel line running from the storage cylinder and terminating at the regulator.
- 1.3.20 **“Service shut-off valve”** means a manually operated shut-off valve fitted on the cylinder, which can open or shut off the gas supply for maintenance, servicing or emergency requirements.
- 1.3.21 **“Shall”** The word “shall” is used to indicate a requirement that must be adopted to comply with this Standard.
- 1.3.22 **“Should”** The word “should” is used to indicate a recommended practice.

- 1.3.23 “**Shut-off valve**” means a valve for stopping gas flow.
- 1.3.24 “**Statutory authority**” The Government Department or agency responsible for the particular aspect (See Appendix B).
- 1.3.25 “**Upstream**” means the direction against the flow of the stream.

1.4 Special requirements

The fitment of a gas fuel system shall be prohibited in any vehicle with a passenger compartment heating system, which draws air from the engine compartment unless the heating system is made inoperable and gas-tight to the passenger compartment.

2.0 CYLINDER

2.1 Design approval

- 2.1.1 Cylinders shall be approved / endorsed by the PESO as per Gas Cylinder Rules, 2016 as amended from time to time.
- 2.1.2 The weight of the gas cylinder(s) will affect the unladen weight of the vehicle and therefore consideration of the effect on the legal and manufacturer’s rating and axle loadings should be considered.
- 2.1.3 In no circumstances shall the vehicle’s critical load distribution affecting safety considerations be compromised.
- 2.1.4 Cylinders shall be re-tested as per Gas Cylinder Rules, 2016, as amended from time to time.

2.2 Fittings on cylinders and filling connection

2.2.1 Cylinder valve

Each cylinder shall have a manual cylinder shut off valve mounted directly on it capable of shutting off all gas flow from that cylinder. Cylinders and shut-off valve assemblies shall be approved / endorsed by the PESO, as per Gas Cylinder Rules, 2016, as amended from time to time.

- 2.2.1.1 following Accessories fitted to the LNG tanks as approved / endorsed by PESO

2.2.1.1.1 Automatic valve

An automatic valve shall be installed in the fuel supply line, either directly on every LNG tank (in a protected position) or as close as practicable after the vaporizer in the LNG system.

The automatic valve shall be operated such that the fuel supply is cut off when the engine is switched off, irrespective of the position of the ignition switch, and shall remain closed while the engine is not running. A delay of 2 seconds is permitted for diagnostic.

2.2.1.1.2. Excess flow valve

The excess flow valve can be fitted inside or directly on the LNG tank (in a protected position).

2.2.1.1.3. Pressure relief valve (primary)

The primary pressure relief valve outlet shall be connected to an open ended pipe-away system to move vented gas away to a high level. Consideration shall be given to preventing any blockage or freezing of the pipe-away. The LNG primary relief valve shall not vent into the gas tight housing (if fitted).

2.2.1.1.4. Pressure relief valve (secondary)

The secondary relief valve may relieve gas immediately from its outlet. Protection from water ingress and damage shall be considered. The secondary relief valve outlet shall not be connected to the same pipe-away as the primary relief valve. The LNG secondary relief valve shall not vent into the gas tight housing (if fitted).

2.2.1.1.5. Manual fuel shut off valve

The manual fuel shut off valve shall be mounted directly on the LNG tank (in a protected position). It should be readily accessible. The manual fuel shut off valve can be integrated into the automatic valve.

2.2.1.1.6. Manual vapour shut off valve

The manual vapour shut off valve shall be mounted directly on the LNG tank (in a protected position). It should be readily accessible.

2.2.1.1.7. Vent line or connector

The vent line or connector may be mounted inside or on the LNG tank (in a protected position). It should be readily accessible. The vent connector shall be suitable for the purpose at temperatures indicated in Annex 5O of UN R110 for the working pressure of the LNG tank.

2.2.1.1.8. Venting management system

The primary pressure relief valve shall be piped to a vent stack which extends to a high level. The primary and secondary relief valve outlets shall be protected from fouling by dirt, debris, snow, ice and/or water. The vent stack shall be sized to prevent flow restriction due to pressure drop. Gas exiting the vent stack or secondary relieve valve shall not impinge on enclosed areas, other vehicles, exterior-mounted systems with air intake (i.e. air-conditioning systems), engine intakes, or engine

exhaust. In the case of dual tanks, the primary relief valve outlets piping for each tank may be manifold to a common stack.

2.2.2 Filling Connection

The filling connection shall be of the NZS / NGV-1 or any other type as specified by the Government of India from time to time for gaseous fuelled vehicles. For heavy duty vehicles it is mandatory to use Automatic gas Cylinder Valve with Pressure Relief Device (PRD) as approved / endorsed by PESO under Gas Cylinder Rules, 2016 as amended from time to time.

The basic dimensions for NZS type are as given in Appendix D and recommended sizes of NGV – 1 type of filling connection are SAE 9/16” and 7/8”. However, the vehicle manufacturer / kit installer may seek the guidance from The Gas Authority of India Ltd. / Ministry of Petroleum and Natural Gas about the use of specific type of NGV – 1 nozzle.

In case of LNG, the refilling receptacle shall be as per UN R110 or equivalent standard, The LNG filling receptacle shall be made out of non-sparking material and should comply with the no igniting evaluation tests described in ISO 14469 1 or equivalent standard. However, the vehicle manufacturer / kit installer may seek the guidance from PESO / Ministry of Petroleum and Natural Gas about the use of specific type of LNG receptacle.

When the gas container or tank is installed in the passenger compartment or an enclosed (luggage) compartment the filling unit shall be located at the outside of the vehicle.

2.2.3 The NZS type filling connection shall be provided with a captive dust plug and NGV-1 type filling connection shall be provided with dust protection cap.

2.2.4 Position of filling connection

The filling connection shall be located in suitably protected and ventilated location, usually the engine compartment. In case of LNG both tank mounted and remote mounted options of LNG receptacles will be allowed. Remote mounted receptacle will be permitted in case of multi tank vehicle configuration and buses where tanks are mounted inside the body structure. It shall comply with the following:

- (a) The filling connection is made and filling is supervised from outside the vehicle.
- (b) The filling connection is protected by being located in a recess below the surface of a body panel, or by being located so that equivalent protection is provided by the construction of the vehicle.

- (c) The filling connection shall be attached to motor vehicle in such a manner as to resist, without permanent deformation of the mounting attachment, a proof load of 50 kgf applied in the forward and reverse directions of travel of the vehicle.
- (d) The proof load shall be applied by full engagement of the filling connection and shall be representative of attempted movement of the vehicle while refueling.
- (e) The filling operation can be carried out without requiring the operator to lie or crawl under the vehicle or be otherwise subjected to inconvenience, discomfort or hazard.

2.2.5 Refueling Interlock Device (Not applicable to LNG vehicle)

Filling connections in motor vehicles shall be fitted with a system that prevents the engine starting when the dust plug or dust protection cap is removed. This system shall isolate the starting device of the vehicle. Any other system that isolates the engine starting shall be considered.

2.2.6 Non-return valve/ Check valve

There shall be a non-return valve fitted on the refueling line to prevent the return flow of gas from the cylinder to the filling connection. The non-return valve shall be located as close to the filling connection as it is practicable.

In case LNG, the check valve shall meet the requirements of UN R110 or equivalent standard.

2.2.7 Excess flow valve

A device may be fitted in the fuel line preferably at the outlet of the cylinder valve which prevents the total contents of the cylinder from discharging to atmosphere in the event of rupture to any part of the fuel line or components.

In case LNG, the excess flow valve shall meet the requirements of UN R110 or equivalent-standard.

2.2.8 Diesel Fuel cut off

A device / mechanism to be provided in the Dual fuel system for cutting of the diesel supply while filling gaseous fuel in the vehicle.

2.3 Location, Ventilation and Mounting of Cylinders

2.3.1 Cylinders, Fittings and Pipe work.

- 2.3.1.1** Cylinder shall be mounted in a protected location inside the perimeter of the vehicle. Cylinders shall not be located so that the vehicle driving characteristics are adversely affected.

Note: A cylinder shall not be fitted in any internal location when a suitable external location is available.

2.3.1.1.1 Provisions on components fitted to the LNG tank approved by PESO

2.3.1.1.1.1 The LNG tank shall be equipped at least with the following components, which may be either separate or combined (special care shall be taken to prevent LNG trapping):

- a) Pressure relief valve;
- b) Manual valve;
- c) Automatic valve;
- d) Excess flow device.
- e) The tank may be equipped with a gas-tight housing, if necessary.

2.3.1.1.2 Leakage and venting from LNG tanks

In the case of LNG tanks are located in enclosed spaces for extended periods of time (e.g. for service), leakage and venting of natural gas (or other flammable substances) from the tank shall be dealt with properly to avoid the dangers due to releasing flammable substances in enclosed spaces.

2.3.1.2 LNG Tank supports

The manufacturer shall specify the means by which the tank(s) shall be supported for installation on vehicles. The manufacturer shall also supply installation instructions, including maximum clamping force and torque to not cause unacceptable stress in the tank or damage to the tank surface.

2.3.1.2.1 Cylinder shall not be fitted in any position behind the driver seat (seat adjusted to rear most position), which will hinder the driver seat adjustment unless specifically approved by the testing agency.

2.3.1.2.1.1 For internally mounted cylinders:

Where a cylinder is located within the operator cabin of a vehicle, either:

- (a) The whole body of the cylinder together with its attached components and fittings shall be enclosed in a compartment; or
- (b) The valves and pipe connections associated with or attached to the cylinder shall be enclosed in a localized sub-compartment, which is attached to the cylinder and vented to the atmosphere.

Provision shall be made for ready access to the cylinder valve in all installation arrangements.

2.3.1.2.1.2 For externally mounted cylinders:

In no case shall cylinder valves be positioned less than 200 mm from the extremities of the vehicle unless they are protected to minimize the possibility of damage due to collision, overturning or other accident.

Where the operation of the vehicle is such, that the cylinder will be subjected to impact damage from loose metal or other objects being thrown up from the road, effective shielding against these shall be provided.

2.3.1.3 The cylinder shall be situated and vented so that any gas escaping due to leakage from the cylinder valve shall not enter the vehicle passenger compartment or driver space.

2.3.1.4 The clearance between the cylinder the exhaust shall not be less than 75 mm.

2.3.1.5 For Heavy Motor Vehicles Only

2.3.1.5.1 In the case of heavy motor vehicles, the number of cylinders likely to be required will be of sufficient weight to affect the legal maximum vehicle weight constraints. The effects of the chosen position of the cylinders on the following criteria must be assessed, and if necessary, a reduction in the allowable payload of the vehicle under study be considered.

- (a) The original manufacturer's maximum design axle loadings.
- (b) The maximum allowable axle loadings.
- (c) The maximum gross vehicle weight and/or gross combination weight allowed by the original manufacturer.

A number of alternative cylinder mounting positions may have to be considered in order to minimize the effects mentioned above. The effects of removing or replacing existing diesel fuel tanks on weight distribution of the vehicle should also be taken into account in the above calculations.

NOTE- Vulnerability of cylinders and fittings to damage during loading and unloading of the vehicle or load shift or spillage shall be taken into account.

2.3.2 (a) Cylinder shall not be fitted in any position behind the driver seat (seat adjusted to rear most position), which will hinder the driver seat adjustment unless specifically approved by the testing agency.

(b) Cylinder shall not be fitted in a position beneath the vehicle that decreases the effective ground clearance.

(c) In case of heavy vehicles (bus having more than 3.5 GVW), for fitment of cylinders on roof, the strength of roof shall be validated by testing agency based on design calculation provided by vehicle manufacturer / kit manufacturer / kit supplier.

(Refer to Fig. 1 for 4-wheeler with GVW below 3.5 tonnes)

2.3.3 Vehicle mounted cylinders

2.3.3.1 A cylinder installed in a vehicle shall be permanently mounted and filled in that position.

2.3.3.2 Cylinder location ground clearance

Cylinders shall be located in accordance with all the following requirements:

(a) The vehicle mass for determining ground clearance shall be the laden mass, including permanent non-standard attachments to the vehicle with all fuel, water and oil containers full.

(b) Cylinders installed between and behind axles shall not be lower than the lowest of the following points and surfaces forward of the cylinder (refer fig. 1 for 4-wheeler below 3.5 tonnes and fig. 2 for 4-wheeler and above exceeding 3.5 tonnes GVW):

- (i) The lowest structural component of the body
- (ii) The lowest structural component of the frame or sub-frame, if any
- (iii) The lowest point of the engine
- (iv) The lowest point on the transmission (including the clutch housing or torque converter housing as applicable) but excluding differential housings.
- (v) The original fuel tank or tanks and or brackets
- (vi) Approach and departure clearances shall be below planes defined in figure 2 (for 4-wheeler and above exceeding 3.5 tonnes GVW).

Note- Suspension spring U bolts are not classified as structural components.

(vii) In any case the lowest point of the cylinders shall not be lower than a horizontal line taken at the lowest point of the front and rear wheel rims (line AB in Figure 2) (for 4-wheeler and above exceeding 3.5 tonnes GVW).

b) Ramp angle (for 4-wheeler below 3.5 tonnes GVW): The cylinder(s) shall not be lower than a point defined by a ramp angle of 17 deg. (Refer Appendix F for calculation).

To calculate ramp angle the following measurements shall be taken (refer Fig. 1)

- (i) A plane through the centre line point of road contact of the front wheel (B), sloping upward to contact the lowest structural point of the vehicle midway between the axles (A) (line AB in Fig 1); and

(ii) A plane sloping from point (A) defined in (i) downward to the centre line point of road contact of the foremost rear axle wheel (C) (line AC in Fig. 1).

(c) Departure angle (for 4-wheeler below 3.5 tonnes GVW)

(i) The cylinders shall lie within an area C-D in fig. 1.

(ii) When calculating departure angle the measurement shall be taken along angular plane tangential to the centre line point of road contact of the rear most axle wheel sloping upward and outward to the extremity of the permanent body work or original equipment bumper bar whichever is the lower.

(d) All clearances shall be measured to the bottom of the cylinder or to the lowest fitting, support or attachment on the cylinder or cylinder housing, whichever is lowest.

2.3.4 Internal cylinders

Where a cylinder is located within the body shell of a vehicle, either:

(a) The whole body of the cylinder together with its attached components and fittings shall be enclosed in a compartment; or

(b) The valves and pipe connections associated with or attached to the cylinder shall be enclosed in a localized sub-compartment, which is attached to the cylinder and vented to the atmosphere.

Provision shall be made for ready access to the cylinder valve in all installation arrangements.

Note - The luggage boot of a car is not considered to be acceptable as a cylinder compartment under (a) above, because of difficulties concerning effectiveness of sealing, the maintenance of ventilation openings, and the presence of electrical equipment in most boots.

2.4 Construction of compartments and sub-compartments

2.4.1 A cylinder compartment or sub-compartment shall comply with the following requirements:

(a) Construction shall be such that any gas which might leak from any fittings, component or piping, cannot pass to any other enclosed compartment, passenger space or luggage space of the vehicle

(b) When a sub-compartment has been subjected to hydrostatic internal pressure of 30 kPa applied for 5 min, sealing materials or gaskets shall not be displaced or otherwise lose integrity during the test.

- (c) Hatches, covers, or construction joints, which may need to be opened or dismantled during maintenance or inspection, shall be capable of being opened at least 10 times without adverse effects on durability. Hinges and locking devices of hatches and covers shall be designed to prevent the dislodgment of the hatch or cover when in the closed and locked position.
- (d) The construction shall be such that when subjected to a pushing force of 60 kgf, applied at any point on any external face of the sub-compartment, any resultant damage shall not be of a nature to permit gas leakage in the event of pressure testing as in (b) above. The pushing force shall be applied by a measuring instrument having a flat circular face of 20 mm diameter.
- (e) It shall be possible to operate the cylinder service shut-off valve in the installed position. The valve may be arranged so that it can be operated from some internal area of the vehicle provided that the sealing of the compartment or sub-compartment shell is maintained by one of the following means, as appropriate:
 - (i) If a valve actuating device passes through the shell a gas-tight seal shall be provided.
 - (ii) If the actuating handle is wholly within the shell, access shall be a gas-tight captive hatch. The design shall not need tools to open the hatch.
- (f) A compartment or sub-compartment shall not contain ignition sources or electrical equipment or wiring unless it is intrinsically safe.

Note - Items (b), (c) and (d) are intended to be the basis of approval for proof of design.

2.4.2 Ventilation

One or more vents to the outside of the vehicle shall be provided, the aggregate area of which is not less than 550 mm² for vehicles other than 2- wheeler and 3-wheeler and 250 mm² for 2- wheelers & 3-wheelers. The vents shall be so located as to exhaust any gas, which may accumulate in the compartment or sub-compartment to atmosphere and shall exit not less than 75 mm from an exhaust pipe or other heat source. (Refer also to 2.4.3 (c)). Holes for venting shall be positioned not less than 40 mm from the edge of a panel or a welded joint or direct load bearing point (refer also to 1.1.4(c)).

2.4.3 Ducting

2.4.3.1 All piping or hoses that pass through an enclosed area of the vehicle shall be within a conduit gas-tight from the vehicle interior, vented unobstructed to outside atmosphere and protected from external damage and shall comply with the following requirements:

- (a) The ducting shall be as short as practicable.

- (b) The connections shall be mechanically clamped and shall not depend on adhesives or sealing compounds to retain them in place. Protection in the form of a gasket shall be provided to prevent damage to the ducting material by the clamping device.
- (c) The material of the conduit used for ducting shall be sufficiently strong to resist mechanical damage, preserve venting integrity, protect the piping or hose within it, shall not support combustion and shall meet the following minimum criteria:
 - (i) The conduit shall withstand an internal pressure of 30 kPa.
 - (ii) The conduit shall not suffer sufficient damage to permit leakage when tested by applying a 60 kgf static force applied through 20 mm diameter, in the following manner.
 - (1) Applied to a free length of conduit (minimum length of 500 mm).
 - (2) With the conduit connection clamped up in position the force then applied 5 mm from the end of this coupling so as to place the connection in tension.
 - (iii) Flammability. The material shall conform to SAE J 369a class SE/NBR
 - (iv) Presence of resistance to ultraviolet degradation agent shall be confirmed.

Note – Item (c) shall be the basis of approval for proof of design of the conduit.

2.4.3.2 Pliable material

A sub-compartment may be constructed of pliable material attached to the cylinder so that the cylinder valve, piping and connections are contained within the sub-compartment. The pliable material shall meet the requirements of this clause and shall be clearly marked accordingly.

2.4.3.3 Where the sub-compartment is removed to initiate repairs or at the periodic inspection special attention shall be given to the inspection of the material to ensure that no degradation of material has taken place. Any sub-compartment showing signs of degradation shall be replaced.

2.4.3.4 The cylinder valve actuating device position shall be clearly identified and shall have provided adequate material to allow closing of the valve without damage to the sub-compartment sealing.

2.4.3.5 The pliable sub-compartment shall be shielded or installed in a protected location to prevent damage, from unsecured objects and abrasion and:

- (a) The material shall be sufficiently strong to resist mechanical damage, preserve venting integrity, shall not support combustion and shall meet the following minimum criteria:

- (i) Resistance to cold cracking. The material shall withstand a bend of 180° applied within 0.5 seconds around a 6 mm diameter former at temperature of -35°C without cracking.
- (ii) Flammability. The material shall conform to SAE J369a class SE/NBR.
- (iii) Presence of resistance to ultraviolet degradation agent shall be confirmed.

Note – Item (a) shall be the basis of approval for proof of design.

2.5 Cylinder(s) installation

2.5.1 For CNG Cylinders

2.5.1.1 Attachment to vehicle (refer also to 2.5.1(e))

Cylinders shall be securely attached to the vehicle to prevent slipping, rotating and jarring loose, in accordance with the following requirements:

- (a) The method of attachment shall not cause undue stresses or wear in the cylinder shell;
- (b) The mounting method shall not significantly weaken the vehicle structure, and reinforcement shall be added where necessary to ensure compliance with (c) below. An air gap of not less than 5 mm shall be provided between the cylinder and vehicle structure;
- (c) The force necessary to separate the cylinder from the vehicle shall not be less than 20 times the mass of the full cylinder in any direction.

The strength of the anchorages may be established by static test (forces directed through the centre of mass of the cylinder).

- (d) In the absence of testing or where calculations are impracticable, the following design requirements shall apply:
 - (i) There shall be at least 4 points of attachment to the vehicle structure. The spacing between these shall be sufficient to ensure the stability of the cylinder.
 - (ii) Where a cylinder is anchored to steel sheet metal the sheet metal shall be reinforced by a plate of not less than 3600 mm² and a thickness of not less than 2.5 mm or appropriate thickness supported by the calculation or test report. It is preferred that a round washer be used but where a square plate is fitted the corners shall be radiused. Any such reinforcement plate/washer shall be contoured to the shape of the sheet metal or chassis rail.

Table 1		
Cylinder size (Water capacity in ltrs.) Over, up to and including L	Band dimensions – Minimum nominal size (mm)	Bolt or stud diameter for strap or flange mountings minimum nominal size (mm)
0 - 30	30 x 2	10
30 -100	30 x 3	10
100 - 150	50 x 6	12
Above 150	Specific design required	

- (iii) Where anchorage bolts pass through a hollow section, provision shall be made to prevent collapse of that section under load.
- (iv) Anchorage bolts or studs shall have a diameter not less than that shown in Table 1 and shall conform to strength grade 8.8, IS:1364 or equivalent ISO:4014 with nuts to IS:1364 or ISO:4032.
- (v) Where clamping bands are used, at least two steel bands per cylinder shall be provided, the dimensions, of which shall not be less than those in Table 1.

To prevent possibility of external corrosion where clamping bands are used a non-moisture retaining hard rubber or equivalent material shall be provided on the inner side of the bands. Similar adequate protection to the cylinder shall also be provided wherever the cylinder rests against other metal objects such as the mounting frame.

- (vi) Where the attachment is by means of clamping bands there shall be a positive means of resisting end loads on the cylinder by means of providing suitable end stoppers (Except for transverse mounted cylinders).
 - (vii) Screwed fasteners or clamping devices shall either be inherently resistant to loosening or be locked or pinned after tightening.
- (e) The chassis of heavy motor vehicles can be subjected to considerable torsional and bending deflections even under normal operating conditions. Mounting of cylinders to chassis rails must take these deflections into account and the cylinder mounting method chosen must not unduly prevent these deflections occurring.

2.5.2 For LNG Cylinders**2.5.2.1 LNG Cylinder installation guidelines (ref Fig 5)****2.5.2.1.1 Mounting of LNG Tank :**

The manufacturer shall specify the means by which the tank(s) shall be supported for installation on vehicles. The manufacturer shall also supply installation instructions, including maximum clamping force and torque to not cause unacceptable stress in the tank or damage to the tank surface.

Installation instructions shall be provided to ensure that the cylinders will not suffer unacceptable damage during installation and during normal operation over the intended service life.

Where the mounting is specified by the manufacturer, the instructions shall contain where relevant, details such as mounting design, the use of resilient gasket materials, the correct tightening torques and avoidance of direct exposure of the cylinder to an environment of chemical and mechanical contacts.

- a. Where the mounting is not specified by the manufacturer, the manufacturer shall draw the Installer's attention to possible long term impacts of the vehicle mounting system, for example: vehicle body movements and cylinder expansion/contraction in the pressure and temperature conditions of service.
- b. The container and/or tank shall be permanently installed in the vehicle and shall not be installed in the engine compartment
- c. The container and/or tank shall be installed such that there is no metal to metal contact, with the exception of the fixing points of the container(s) and/or tank(s).
- d. When the vehicle is ready for use the fuel container and/or tank shall not be less than 200 mm above the road surface. This shall not apply if the container and/or tank is adequately protected, at the front and the sides and no part of the container is located lower than this protective structure.
- e. The LNG fuel container(s) and/or tank(s) shall be mounted and fixed so that the following accelerations can be absorbed (without damage occurring) when the container(s) and/or tank(s) are full:

I. Vehicles of categories M2 and N2:

- 10 g in the direction of travel;
- 5 g horizontally perpendicular to the direction of travel.

II. Vehicles of categories M3 and N3:

- 6.6 g in the direction of travel;
- 5 g horizontally perpendicular to the direction of travel.

A calculation method can be used instead of practical testing if its equivalence can be demonstrated by the applicant for approval to the satisfaction of the Technical service.

In addition, many chassis manufacturers specifically prohibit the welding of attachment points to their chassis members and in some cases also prohibit the drilling of additional mounting holes in the chassis members. For any proposed chassis modification due consideration must be given to the particular chassis manufacturer's restrictions with respect to welding, drilling and sealing of existing holes. Advice on these matters can be obtained from the chassis manufacturer.

2.5.3 Cylinder manifolding

Where more than one cylinders is fitted to a vehicle it is preferable the cylinders be manifolded together in such a way that all can be simultaneously filled from any fill point on the vehicle. Each cylinder shall retain its required individual cylinder valve.

2.5.4 More than one cylinder

Specific design may be required for the mounting attachment. Refer also 1.1.4.

2.5.5 Cylinder identification markings should be capable of being read when in the installed position.

2.6 Shielding

2.6.1 Cylinders shall be installed to ensure that valves and connections on cylinders shall be protected to minimize the possibility of damage due to accidental contact with stationary objects or from loose objects thrown up from the road. Valves shall be protected to minimize the possibility of damage due to collision, overturning, or other accident. Parts of the vehicle may be used to provide such protection to valves and fittings.

3.0 GAS FUEL LINE

3.1 Gas fuel line - High & Low pressure fuel line

3.1.1 For CNG / BIO-CNG: Rigid piping and connections for use with pressures exceeding 2.15 MPa shall comply with IS 15716.

In case of LNG Rigid piping which coming in contact with cryogenic gas (subjected to Tank pressure) shall meet requirements UN R110 or equivalent-standard.

Any LNG fuel lines downstream of the heat exchanger / vaporizer is suitable of being treated as CNG fuel lines.

LNG rigid pipeline after heat exchanger / vaporizer shall meet requirements of IS: 15716 or equivalent standards.

LNG rigid fuel lines shall be made of austenitic stainless steel or copper, either seamless or welded.

LNG fuel line shall be insulated or protected in those areas where low temperature can damage other components and/or harm people. Bite-type compression joints are not permitted for LNG.

- 3.1.2 CNG / BIO-CNG fuel line and connections for use with pressures exceeding 100 kPa but less than 2.15 MPa shall be tested as per IS 15722 .

In case of LNG flexible piping which coming in contact with cryogenic gas shall meet requirements of UN R110 or equivalent standard.

Any LNG fuel lines downstream of the heat exchanger / vaporizer is suitable of being treated as CNG fuel lines.

LNG flexible pipeline after heat exchanger / vaporizer shall meet requirements of IS: 15722 or equivalent standards.

- 3.1.3 Flexible hose exceeding 2.15 MPa Flexible hose shall meet the following requirements

- 3.1.3.1 Flexible hose shall comply with IS 15718

- 3.1.3.1.1 In case of LNG flexible piping hoses which coming in contact with cryogenic gas shall meet requirements of UN R110 or equivalent standard. It shall be identifiable as being suitable for LNG.

- 3.1.3.1.2 Any LNG fuel lines downstream of the heat exchanger / vaporizer is suitable of being treated as CNG fuel lines.

- 3.1.3.1.3 LNG flexible hoses after heat exchanger/ vaporizer shall meet requirements of IS: 15722 or equivalent standards.

- 3.1.3.2 Ageing Test

When hose is aged for 72 hrs at 125 ± 2 deg C and then tested in accordance with IS : 3400 for the tensile strength and elongation at break of the lining and cover shall not vary from the corresponding pre-determined unaged values by more than 40%.

- 3.1.3.3 Installation

- 3.1.3.3.1 The hose shall be supplied and fitted as a fully made up assembly and proof tested to not less than 27.5 MPa with fittings attached prior to installation.

- 3.1.3.3.2 In addition to the requirements of 3.1.5 of this Standard, flexible hose shall be installed in accordance with the following requirements:

(The exception being the flexible hose used between the towed and towing vehicle)

- (a) The bend radius of the hose shall not be less than 35 mm or the manufacturer's recommended specifications.
- (b) Flexible hose shall be secured to the chassis frame or vehicle body by clips, secured at not more than 300 mm apart and shall be fitted prior to and after each bend.
- (c) Such clips shall be of sufficient resilience and secured to the vehicle in such a manner so as to prevent lateral movement and damage to the hose and not work loose.
- (d) The hose shall be located as far away as practicable from the exhaust system. In no case shall it be closer than 100 mm. Where the hose is situated between 100 mm and 200 mm from the exhaust, shielding shall be provided which shall take the form of one piece of sheet metal located midway between the exhaust and fuel line.

3.1.3.4 Inspection

3.1.3.4.1 At the time of periodic inspection, the hose shall be inspected for twists, kinks and damage or abrasions to the cover, which expose the wire. The hose shall be condemned on detection of any one of these defects.

3.1.3.4.2 At no time shall flexible hose be placed back into service after removal from the vehicle, the exception being flexible hose designed for and used between the towed and towing vehicle.

3.1.4 Joints and connections

3.1.4.1 Every joint or connective fitting in rigid high pressure fuel line shall be tested for minimum test pressure of 70 MPa without leakage or failure.

3.1.4.2 The number of joints and connections shall be the minimum for the inclusion of all components.

3.1.4.3 Joints or connections in a gas fuel line shall be in accessible positions for easy inspection.

3.1.4.4 Connection means shall provide positive retention of the fuel line in the fitting (e.g. by double inverted flaring of the tube end).

3.1.5 Securing and location

3.1.5.1 High pressure piping and hoses in vehicles shall comply with the following:

- (a) No gas fuel line inside the part of any vehicle occupied by the driver or passenger shall be outside the sealed and vented enclosure (except as provided for in 2.4.3)
- (b) All gas fuel lines shall be positioned for protection from the possibility of damage by impact, accident or loose objects thrown by the vehicle wheels / tyres. Parts of the vehicle may be used to provide such protection.
- (c) Gas fuel lines shall not be located inside box sections or in other inaccessible locations nor shall they be installed in any location, which is not adequately protected from sources of heat, abrasion, or from impact.
- (d) Use of the drive shaft tunnel for fuel line location is not desirable or recommended. If such routing is the only possible practicable method of installation, the fuel line must be positioned along the lower corner of the tunnel with the underside of the fuel line not more than 15 mm above the intersection with the floor pan. The fuel line should follow this route for the shortest distance possible. The fuel line shall have a minimum clearance of 40 mm with the drive shaft under all operating conditions. This method is not applicable to vehicles where the open axle shaft passes through a tunnel.
- (e) Use of the wheel arch for fuel line location is not desirable or recommended.
- (f) Fuel lines shall follow the shortest practical route taking into account the requirements of 3.3.2.
- (g) Rigid fuel lines shall be effectively secured to the chassis frame or vehicle body by clips spaced not more than 600 mm apart for other vehicles. In order to prevent the possibility of fretting corrosion or erosion of the fuel line cushioning must be provided to protect the fuel line from both the chassis/body and the clips themselves. Suitable grommets must be provided where the fuel line passes through anybody panel.
- (h) Manifolds used in multi-cylinder applications shall be installed in a protected location. Manifold branch pipelines shall be sufficiently flexible to prevent damage to the lines, valves and fittings due to vibration, expansion or contraction.
- (i) In no case shall the clearance between the exhaust system and the fuel line be less than 75 mm.
- (j) Fuel lines shall not be installed where any part will be permanently hidden from sight or cannot be inspected or easily replaced (except as provided for in 2.4.3).

3.2 Gas fuel line - pressure not exceeding 100 kPa (low pressure fuel line)

3.2.1 All CNG / BIO-CNG fuel lines for use for service pressure not exceeding 100 kPa (low pressure hose) shall comply with the following:

(a) Such low pressure fuel line shall be of flexible material complying with IS: 15722 or ISO 15500 or equivalent. Low pressure fuel line shall withstand test pressure as per IS 15722 the maximum pressure likely to be encountered in service and shall comply with 3.1.5.1 (a) to (f) inclusive and (j). In case of LNG flexible piping which coming in contact with cryogenic gas shall meet requirements of UN R110 or equivalent standard. It shall be identifiable as being suitable for LNG.

LNG flexible hoses after heat exchanger / vaporizer shall meet requirements of IS: 15722 or equivalent standards.

Any LNG fuel lines downstream of the heat exchanger / vaporizer is suitable of being treated as CNG fuel lines

(b) Joints and connections for low pressure fuel lines shall be suitable for use with gaseous fuel and capable of sustaining 5 times the maximum pressure likely to be encountered in service, and shall comply with 3.1.4.2 and 3.1.4.3.

3.3 Flexibility

3.3.1 Low pressure hose shall be of sufficient length to accommodate engine movement.

3.3.2 High pressure fuel line shall be installed so as to accommodate any relative movement between chassis/body and fuel system components or temperature variations in the fuel line.

3.3.3 All runs of rigid fuel line piping between any two components shall be installed with a 'pigtail' or U bend to provide this essential flexibility (Refer 3.3.2).

3.4 Trailers and semi-trailers

The fuel supply line between cylinders and an engine shall not pass between a towed and a towing vehicle unless the following conditions are satisfied:

3.4.1 Low pressure transfer of gaseous fuel

(a) The cylinder pressure shall be reduced to value not greater than 2.15 MPa by use of a primary regulator placed upstream of the towing connection. All such equipment should be recommended for this application by the equipment manufacturer.

(b) All components downstream of the primary regulator must be protected against pressure rise due to failure of any other component by the use of a relief valve which will prevent the pressure experienced downstream of the primary regulator from rising above 3.3 MPa.

- (c) Gas fuel line connecting the towed and towing vehicle shall be flexible hose and shall meet the requirements of SAE 100 R1 or UN R 110 or equivalent standard.
- (d) The flexible fuel line shall be arranged and installed so that the free movement of the hose between towed vehicle and the breakaway coupling shall be minimum required to accommodate all possible movement with the towing coupling engaged.
- (e) A breakaway coupling shall be provided within the connection of the flexible hose between towed and towing vehicle and the rigid fuel line installed on the towing vehicle. The coupling shall be attached to the towing vehicle in such a manner so as not to impede its operation and shall resist, without permanent deformation of the attachment, a proof load of 50 kgf in the forward and reverse direction of travel of the vehicle.
- (f) Hose couplings shall be of the failsafe or dry type having internal valves which prevent the loss of fuel when breakaway occurs or when the coupling is undone.
- (g) The fuel line upstream of the breakaway coupling must be protected by an accessible manually operated isolating valve. If cylinders are present on a towing vehicle an accessible manually operated isolating valve shall also be fitted on the towing vehicle.

Note – The allowable amount of free movement of hose between the towing and towed vehicle shall be such as to minimize whipping of the hose should the hose be severed.

3.4.2 High pressure transfer of gaseous fuel (Refer Fig.3):

Where high pressure gaseous fuel is transferred between the towing and towed vehicle 3.4.1 (c), (d), and (g) shall apply along with the following clauses:

- (a) A quick-connect coupling shall be provided within the connection of the flexible hose between towed and towing vehicle and the rigid fuel line installed on the towing vehicle.
- (b) For any tractor unit provided with gaseous fuel storage cylinders, the system shall have installed on the tractor as close as practicable to the coupling a check valve to prevent flow of gas from the cylinders on the tractor through the coupling.
- (c) The system shall have installed on the trailer downstream and as close as possible to the quick connect coupling, a manual venting valve, having 3 ports. The valve shall be fitted in such a way that in one position the flow of gas from the cylinders through the excess flow valve will be permitted while in the other position the fuel line from the cylinders is isolated and the line through the coupling, is vented to atmosphere.

A permanent label shall be provided “MANUAL VENTING VALVE” in such a way as to clearly indicate the position and function of the valve.

- (d) The manual venting valve is to be operated before the disconnection of the coupling thus releasing pressure from the coupling and fuel line between the check valve in the line of the towing vehicle and the manual venting valve. This venting operation is to be conducted in an open, well ventilated space at least 15 meters from any naked flames or other source of ignition.
- (e) A plate shall be permanently attached to the fuel line next to the coupling and shall be marked as follows: “DANGER: NO SMOKING. PRIOR TO UNCOUPLING, RELEASE LINE PRESSURE AT MANUAL VENTING VALVE.”

Note – The allowable amount of free movement of hose between the towing and towed vehicle shall be such as to minimize whipping of the hose should the hose be severed.

4.0 GASEOUS FUEL CONTROL EQUIPMENT

4.1 Definition

- 4.1.1 The gaseous fuel control equipment includes all the equipment necessary to convert gaseous fuel at high pressure at the cylinder gaseous fuel air mixer/injector for supply to the engine.

In case of heavy motor vehicle, engine control equipment includes all the equipment used to convert a compression ignition engine to run on a gaseous fuel. This includes devices such as fuel provision and control device, the ignition system (if one is used), the speed and/or load governing device (if any), and any engine protection devices such as temperature and pressure alarms, and knock detection systems.

4.2 Control Equipment

4.2.1 Filter

At the termination of every gas service fuel line immediately prior to any regulator component there shall be fitted a properly designed filter capable of removing all particulate matter from the fuel that could cause malfunction of such regulator components.

4.2.2 Gaseous fuel- shut-off valve

- 4.2.2.1 This valve shall shut-off fuel supply to the engine when activated by the fuel change over control on dual fuel/ bi-fuel fuel operation and by the ignition switch on single fuel operation. Normally this is a regulator component but in any case it shall be located downstream of the filter.

In case of LNG it shall meet the requirements of UN R110 or equivalent standard. An automatic valve shall be installed either directly on the tank or as close as practicable after the vaporizer in the LNG system.

This valve shall automatically shut-off the fuel supply to the engine unless the following conditions are satisfied:

- (a) The ignition is on;
- (b) The engine is turning;

4.2.2.2 Service shut-off valve

A service shut-off valve shall be installed in the high pressure line between the cylinder valve and any other valve or component within the engine compartment and as close as practicable to the Regulator, however it is acceptable to install the valve at the refueling point. It shall be possible to readily operate the valve in the installed position at all times in particular during the refueling operation. A permanent label shall be provided 'CNG / BIO-CNG /LNG service shut-off valve' or similar wording to positively indicate its purpose and a positive indication of "Closed" and "Open" positions of the valve shall be clearly marked.

4.2.3 Regulator system and LNG vaporizer/Heat Exchanger

4.2.3.1 The regulator system shall not permit gas to pass after the engine has stopped turning, irrespective of whether the ignition is on or off. The regulator shall be installed so that:

- (a) It is securely mounted as far as practical from the extremities of the vehicle
- (b) It is mounted securely and as close to the engine carburetor position as convenient.
- (c) It is easily accessible for routine maintenance, adjustment and inspection.
- (d) It is situated as far from the exhaust system as practical. Where this distance is less than 150 mm it shall be shielded from radiant heat and any impingement from exhaust gases due to exhaust system failure.
- (e) It is reasonably protected from impact in a collision.
- (f) It allows sufficient free movement of all hoses.
- (g) The water circulating system (where required) is connected in accordance with the manufacturer's instructions, and no flow control valve in the system can shut-off original equipment water flow.
- (h) Where possible, the regulator should be at lower level than top of the radiator, as insufficient water may cause freezing. (Refer also Appendix E for precautions against freezing).
- (i) LNG Heat exchanger - vaporizer

The LNG heat exchanger - vaporizer is the device used for vaporizing the cryogenic liquid fuel and to deliver gas to the engine with gas temperature in between - 40 °C and + 105 °C.

The material constituting the LNG heat exchanger - vaporizer which is in contact with the CNG/LNG when operating shall be compatible with the test CNG/LNG. In order to verify this compatibility, the procedure in Annex 5D of UN R110 shall be used.

The LNG heat exchanger - vaporizer has to comply with the water jacket freezing test. Fill the part of the heat exchanger-vaporizer which normally contains an antifreeze solution, with water to normal capacity and expose it at - 40 °C for 24 hours. Attach 1 m sections of coolant hose to the coolant inlet and outlet of the heat exchanger - vaporizer. Following the freezing conditioning, conduct an external leakage test according to Annex 5 B of UN R 110 at room temperature. A separate sample may be used for this test.

4.2.3.2 The regulator assembly shall not be attached to the engine assembly unless otherwise specified by the manufacturer and then shall be fitted only in accordance with the manufacturer's recommended instructions.

4.2.4 The gas air mixer

4.2.4.1 There shall be installed in the air intake immediately prior to the mixer, a backfire deflector to arrest flash back, which shall meet the requirements of Appendix G of this standard.

In case of heavy motor vehicle, there shall be installed in the air intake prior to the mixer a backfire deflector (original air filter acceptable). In turbo charged applications where rigid piping is fitted from the turbo charger to the intake manifold a pressure relief valve shall be fitted as close as practicable to the intake manifold. Where a volume of gas / air mixer, due to turbo charging or inter/after coolers is contained downstream of the mixer, special precautions will need to be applied to avoid damage to components downstream of the mixer due to backfire.

Vehicle manufacturer / kit manufacturer / kit supplier shall submit test report or certificate complying with the above requirement. It is not necessary to carry out the test if declaration is submitted.

4.2.4.2 The mixer shall be securely mounted and when remotely fitted shall be suitably bracketed to support its own weight and applied working forces.

4.2.4.3 There shall be no air filter element fitted downstream of the gas air mixer.

4.2.5 Dual fuel / Bi- fuel / Dedicated dual fuel system

4.2.5.1 (a) **Dual fuel type:** A Dual fuel engine operation means a two fuel system having diesel as a primary combustion fuel and gas fuel as supplementary fuel, both in a certain proportion throughout the engine operation zone. Such dual fuel engine may be operated on diesel stand-alone mode.

(b) **Bi - fuel type:** A bi-fuel system is defined as a system equipped to operate with either on gas fuel or some other fuel e.g. petrol.

(c) **Dedicated dual fuel** : A dedicated system is defined as a system equipped to operate wholly on CNG / BIO CNG/LNG.

4.2.5.2 For Bi-fuel type

4.2.5.2.1 A shut-off device shall be installed in the bi-fuel fuel system. This device shall shut-off the optional fuel supply to the engine when this fuel is not required.

4.2.5.2.2 If the shut-off device is in the form of a solenoid operated shut-off valve it must be fitted between the fuel pump and the carburetor. The valve shall be mounted securely so that its weight is not taken on any part of the carburetor or fuel lines.

4.2.5.2.3 Where the shut-off device is mounted remotely after the regulator, flexible hose shall be used of sufficient length to accommodate engine movement. In all cases the device shall be mounted in a position reasonably protected from damage in a collision and shall be as far as practicable from high tension electrical equipment.

4.2.5.2.4 Bypass relief device

A bypass relief device shall be installed in the fuel pump or between the fuel pump and the automatic shut-off valve in the liquid fuel line to the carburetor on vehicles equipped with bi- fuel systems for the use of petrol and gaseous fuel. The relief device need not be installed on fuel pumps containing a bypass relief device as original equipment.

4.2.5.2.5 Fuel selection control

A fuel selection control shall be provided which shall have at least three positions, clearly marked for the selection of each of the two fuels. The selection control shall be placed within easy reach of the driver or operator. For vehicles fitted with electronic fuel injection, a two position switch is acceptable.

4.2.5.3 For Dual fuel type

4.2.5.3.1 A shut-off device shall be installed in the Dual fuel system. This device shall shut-off the gaseous fuel supply to the engine when this is not required.

4.2.5.3.2 If the shut-off device is in the form of a solenoid operated shut-off valve it must be fitted between the tank valve and the carburetor/Injector. The valve shall be mounted securely so that its weight is not taken on any part of the carburetor/Injector or fuel lines.

4.2.5.3.3 Where the shut-off device is mounted remotely after the regulator, flexible hose shall be used of sufficient length to accommodate engine movement. In all cases the device shall be mounted in a position reasonably protected from damage in a collision and shall be as far as practicable from high tension electrical equipment.

4.2.5.3.4 Fuel selection control

A fuel selection control shall be provided which shall have at least two modes (Diesel and Dual fuel gas mode), clearly marked for the selection of each of the two fuels. The selection control shall be placed within easy reach of the driver or operator.

4.2.5.3.5 Fuel Level Indicator

A fuel level indicator shall be provided which indicates the level of gaseous fuel in the tank. The level indicator shall be placed within visible range of the driver or operator.

The fitment of fuel level indicator is mandatory.

4.2.6 Installation

4.2.6.1 The gaseous fuel control equipment shall be:

- (a) Installed in positions that are accessible for routine inspection, maintenance and adjustment.
- (b) Mounted securely and reasonably protected from damage in a collision.
- (c) Remote from the vehicle engine exhaust system or protected there from by a metal shield.
- (d) No closer than is avoidable and practicable to any electrical equipment capable of sparking.

4.3 Electrical wiring

4.3.1 All wiring shall be properly installed, taped, clipped or contained in a loom along its length.

4.3.2 Wiring cables shall comply with the requirements of JIS C 3406 or equivalent standard, for only conductor resistance test; spark and immersion test to withstand voltage. The kit supplier / kit manufacturer or vehicle manufacturer shall submit test certificate / test report complying with above requirements.

4.3.3 The electrical circuit shall be provided with a current limiting device. This equipment or fuse shall be dedicated to the gaseous fuel system.

Note – Where fuses are used they should be sized to conform such that 110% of rated current of the circuit – shall not fuse within 60 minutes and at 135% of the rated current of the circuit, it shall fuse within 60 seconds.

A circuit breaker meeting this criterion is acceptable.

4.3.4 Connectors and terminals

4.3.4.1 Connectors and terminals shall be insulated to prevent accidental earthing during operations or routine servicing.

4.4 Pressure indicator / Contents gauge

4.4.1 A pressure indicator to indicate pressure in the gas cylinder, if provided by the manufacturer in addition to Fuel level indicator, shall be fitted in an easily visible position to service personnel at the regulator or fill point preferably within the engine compartment.

In case of LNG, (differential) pressure gauge, if provided, shall meet the requirements of UN R110 or equivalent standard.

4.4.2 A supplementary gauge or electronic gauge may be placed in the driver’s compartment provided any gauge shall be gas isolated from the cylinder or piping to prevent gas leaking into the compartment.

5.0 COMPLIANCE PLATE

5.1 Compliance plate

Compliance plate shall be installed permanently near the filling connection and be clearly visible to the re-fueler a compliance plate shall displaying the following information:

COMPLIANCE PLATE	
a.	Gas Cylinder Identification Number(s)
b.	Date of Installation
c.	Water Capacity (litre) of the Total Installation
d.	Date of the Last Retest
e.	Vehicle Registration/Identification No.
f.	The gaseous fuel installation complies with the safety requirements of AIS 028 (Rev.1) (Part A)
g.	Installed by

6.0 LABELS

6.1 Identification labels

6.1.1 Vehicles using a gaseous fuel system shall be labeled as follows (Dedicated/Bi-fuel/ Dual fuel/Dedicated Dual fuel):

Labels conforming with the specification given in 6.1.1.1 and 6.1.1.2 of this Standard shall be affixed in a vertical position as close to the vehicle number plate as practical or on the left side of the front and on the right of rear safety glass and shall ensure visibility from the front and rear sides.

- 6.1.1.1 The label shall be in position at all times, shall be in good condition, and the shape, colouring and lettering shall be easily identifiable.
- 6.1.1.2 Label shall be coloured white and sized 80 mm x 80 mm square. Label shall have on them the text “CNG / BIO CNG” in a central position not less than 20 mm high, coloured black. The label shall have a black border 1 mm wide, 5 mm inside the outer edge and running parallel to it. The 80 mm dimension is measured from the outer edge. (Refer Appendix C-1 for drawing).
- 6.1.1.3 Label for LNG fueled vehicle shall in accordance with appendix C4.
- 6.1.2 Vehicles using a Dual Fuel/Dedicate Dual Fuel; gaseous fuel system shall be labeled as follows:

Labels conforming with the specification given in 6.1.2.1 of this Standard shall be affixed in a vertical position as close to the vehicle number plate as practical or on the left side of the front and rear safety glass and shall ensure visibility from the front and rear sides.
- 6.1.2.1 The label shall be in position at all times, shall be in good condition, and the shape, colouring and lettering shall be easily identifiable.
- 6.1.2.2 Label shall be coloured orange and sized 80 mm x 80 mm square. Label shall have on them the text “Diesel + CNG / BIO CNG/ LNG” in a central position not less than 15 mm high, coloured black. The label shall have a black border 1 mm wide, 5 mm inside the outer edge and running parallel to it. The 80 mm dimension is measured from the outer edge. (Refer Appendix C-2 for drawing).

7.0 INSPECTION, TESTING AND COMMISSIONING (FOR INSTALLER)

7.1 Commissioning

Prior to initial use, an inspection of the gaseous fuel system and components shall be carried out by, or under the supervision of an Authorized Person / Installer, who shall also carry out a complete examination to ensure the system complies with all relevant sections of this Standard and any other statutory requirements as specified by the Central Government.

7.1.1 Initial inspection and installation certificate

The system shall be leak tested as detailed in 7.2 of this Part of this Standard. The installation shall be inspected for compliance with this Standard and all components shall be checked for operational performance. In the case of dual fuel/bi-fuel fuel installations, the ability for the vehicle to operate on the optional fuel shall also be tested.

When the system conforms to this standard, an installation certificate, as per Annexure VI of AIS-024 (Rev.1) (Part A), signed by authorized person / installer shall be issued to the owner of the vehicle.

For Gaseous fuel buses, checklist as per Annexure VII of AIS-024 shall be duly filled and complied for carrying out third party inspection. This checklist is for third party inspection of fully built Gaseous fuel buses before registration.

7.1.2 Periodic Inspection /preventive maintenance

7.1.2.1 The cylinder, piping and all components of the system shall be examined by an installer for corrosion, deterioration and for any modification affecting compliance with this Standard, at least once in a year or in case of malfunction or accident. The inspection shall include leak testing under 7.2 of this Part of this Standard.

Every gaseous fuel bus manufacturer / installer shall incorporate periodic inspection schedules in the operation and owner's manuals.

7.1.2.2 When the system has been inspected and any defects remedied and the system conforms to this Standard to the satisfaction of the installer, a checklist as per Appendix A (in case of buses it shall be as per Annexure VII of AIS-024 (Rev.1) (Part A)) of this Standard shall be issued to the owner of the vehicle.

7.2 Leak testing

7.2.1 Initial test

At the time of commissioning, the complete pressure system shall be subjected to a pressure test of $200 \pm 10/-25$ Bar by using CNG / BIO-CNG or a gas inert to CNG / BIO-CNG such as nitrogen.

NOTE – It may be permissible to check such a compartment or sub-compartment before installation of the fuel system, provided that nothing in the subsequent installation procedure will negate the validity of the test.

Procedure

7.2.2 Gas tightness of compartments or sub-compartments

7.2.2.1 The compartment or sub-compartment shall be tested at the time of commissioning and subsequently at each periodic inspection to ensure that it is gas tight to the vehicle interior by blowing tracer gas into the compartment or sub-compartment and testing the surrounding atmosphere for gas leakage with a gas detector. Passages between the compartment and outside air, e.g. ventilation provisions, or an access hatch or door in the case of a permanently in-built compartment, should be sealed during testing. Any leakage should be rectified, and testing repeated.

7.2.2.2 Should the compartment or sub-compartment fail the above tests, corrective action shall be taken and the tests repeated until they comply with the test requirements.

- 7.2.3 Where CNG / BIO-CNG is used for testing the following precautions shall be observed:
- (a) Testing shall be carried out under adequately vented conditions.
 - (b) Testing shall be carried out at least 5 m from any open flame or other source of ignition.
- 7.2.4 The operation of the equipment and controls shall also be tested with CNG / BIO-CNG / LNG under normal working conditions to prove satisfactory performance of the entire system and a further leak test shall be carried out using a non-corrosive foaming agent / with a gas detector.
- 7.2.5 A BCF fire extinguisher and dry powder fire extinguisher to meet IS: 2171 and each of 2 kg shall be kept ready within a safe distance. If ignition occurs the service valve should be closed and the extinguisher(s) used to quell any fire, which may continue.

8.0 GARAGING AND REPAIR (FOR INSTALLER)

- 8.1 Garaging and repairing of gaseous fueled vehicles
- 8.1.1 Vehicles fueled with gaseous fuel may be stored or serviced and repaired inside garages provided that the following conditions are observed:
- (a) There shall be no leaks in the fuel system.
 - (b) Such vehicles shall not be parked within 3 m of any sources of ignition.
 - (c) Gaseous fueled vehicles being repaired in garages, unless the fuel is required for engine operation, shall have the cylinder shut-off valve closed and the Gaseous fuel in the service line exhausted by running the engine or depressurizing the line in a well-ventilated area.
 - (d) Vehicles undergoing repairs involving welding or the application of heat, to any part within 1 m of the cylinder, shall have the cylinder removed or shielded from the source of heat.

8.2 Repair Operation

- 8.2.1 Repair operation involving heat shall be carried out with due regard to fire safety.
- 8.2.2 Damaged fuel lines shall not be repaired; in all cases they shall be replaced.
- 8.2.3 Welding, brazing and the application of heat shall not be carried out on any part of the cylinder subsequent to manufacture.

8.2.4 When a vehicle is involved in an accident causing damage to part of all of the gas fuel system or where any part of the system necessitates removal to allow for the repair of the vehicle the system shall, after re-assembly or repair, be tested in accordance with 7.2 and a checklist as per Appendix A of this standard be issued. If applicable the requirements of 8.3.2 shall also be met.

8.3 Scrapping

8.3.1 A vehicle, which is about to be scrapped, shall have its cylinder removed prior to disposal.

8.3.2 Where the cylinder has been subjected to impact or fire damage the cylinder shall be inspected and re-tested by the owner of the vehicle as per Gas Cylinder Rules, 1981, as amended from time to time.

NOTE – There will always be combustible gas in the cylinder until it has been cleared of all traces of flammable vapour or gas.

APPENDIX A	
CHECKLIST FOR INSTALLATION (DEDICATED/BIFUEL/DUAL FUEL/ DESICATED DUAL FUEL)	
A1	This checklist is a guide for the installer when carrying out the inspection prior to issuing installation Certificate. Reference to relevant clauses in this Standard and guidelines issued by Central Government from time to time should be made where appropriate.
(a)	Cylinder:
	Approved by PESO
	Validity of Certificate
	Free from corrosion
	Mounted securely and inside vehicle parameter
	Mounting points free from corrosion and fractures
	Shielded and valves protected where necessary
	5 mm clearance between cylinder to vehicle components provided Ground clearance correct
(b)	Valves:
	Cylinder valve operating correctly
	Burst disc fitted` (NA for LNG valves)
(c)	Filling connection:
	Refueling connection made external to vehicle interior
	Captive dust plug fitted
	Meets proof loading of 50 kgf
(d)	Refueling interlock (NA for LNG):
	Operation correct
(e)	Non-return valve:
	Operation correct free from bypass leakage
(f)	Leak test:
	All valves and fittings leak free

(g)	Vapour sealing:
	Gas tight
(h)	Ducting:
	Free from damage and secure to outlets
(i)	Pliable sub-compartment:
	Ease of operation of cylinder valve satisfactory
	Position identified
(j)	Fuel line:
	Free from damage and corrosion
	Secured to vehicle
	Protected and shielded where necessary
(k)	Joints and connections:
	Leak free
(l)	Gaseous fuel shut off valve/solenoid valve:
	Mounting secure
	Operation correct
	Leak free
(m)	Service shut off valve:
	Operation satisfactory
	Mounted securely
	Leak free
	Identified and operation clearly marked
(n)	Regulator(CNG/Bio CNG):
	Mounting secure
	No gas bypass after engine has stopped turning
	Shielded where necessary
	Leak free

	Vaporizer / Heat Exchanger (LNG):
	Mounting secure
	No gas bypass after engine has stopped turning
	Shielded where necessary
	Leak free
(o)	Control equipment:
	Approved type
(p)	Gas air mixer:
	Securely mounted
	Backfire deflector where applicable
(q)	Bi-fuel shut-off device:
	Operation correct
	Petrol lock off where fitted is mounted securely
	Petrol hose secure joints leak free and free from cracks
	Sufficient flexibility for engine movement
	Bypass device fitted where applicable
(r)	Electrical wiring:
	Current limiting device fitted
	Connections secure
	Terminals insulated to prevent shorting
	Wiring taped and clipped securely
(s)	Compliance Plate:
	Installed and carries correct markings
(t)	Identification labels:
	Located front and rear of vehicle

APPENDIX B			
STATUTORY AUTHORITY APPROVAL			
B1	The type of component in question and its use determine the Statutory Authority Approval in respect of gaseous (Dedicated/Bi-fuel/Dual fuel/Dedicated dual fuel)/LNG (Dedicated vehicles above 3.5 Ton GVW) fuel system components. The Statutory areas of responsibility are:		
	Government Agency	Statutory powers	Scope of application
	B 1.1 Ministry of Road Transport and Highways, Government of India.	Central Motor Vehicle Act, 1988 (CMVA) Central Motor Vehicle Rules, 1989 (CMVR) as amended by government of India from time to time	All gaseous fuel kit components (excluding gas cylinder & its valve(s)) and systems used for the purpose of propelling a motor vehicle on road.
	B 1.2 PESO, Nagpur, Government of India	Gas Cylinder Rules, 2016 as amended by government of India from time to time	Gas cylinder with valves and their accessories.

APPENDIX C-1

LABEL



The sign consists of a sticker which shall be weather resistant.

The colour and dimensions of the sticker shall fulfil the following requirements:

A label shall be placed adjacent to the CNG fill receptacle stating the fuelling requirements. The fuelling requirements shall be as recommended in this standard.

Colours:

Background:	Green
Letters:	Black or black reflecting

Dimensions:

Border width:	4 - 6 mm
Character height:	≥ 25 mm
Character thickness:	≥ 4 mm
Sticker width:	110 - 150 mm
Sticker height:	80 - 110 mm

The word "CNG" shall be centred in the middle of the sticker.

APPENDIX C-2

LABEL



The sign consists of a sticker which shall be weather resistant.

The colour and dimensions of the sticker shall fulfil the following requirements:

A label shall be placed adjacent to the DIESEL+CNG fill receptacle stating the fuelling requirements. The fuelling requirements shall be as recommended in this standard.

Colours:

Background:	Orange
Letters:	Black or black reflecting

Dimensions:

Border width:	4 - 6 mm
Character height:	≥ 25 mm
Character thickness:	≥ 4 mm
Sticker width:	110 - 150 mm
Sticker height:	80 - 110 mm

The word "DIESEL+CNG" shall be centred in the middle of the sticker.

APPENDIX C-3

LABEL

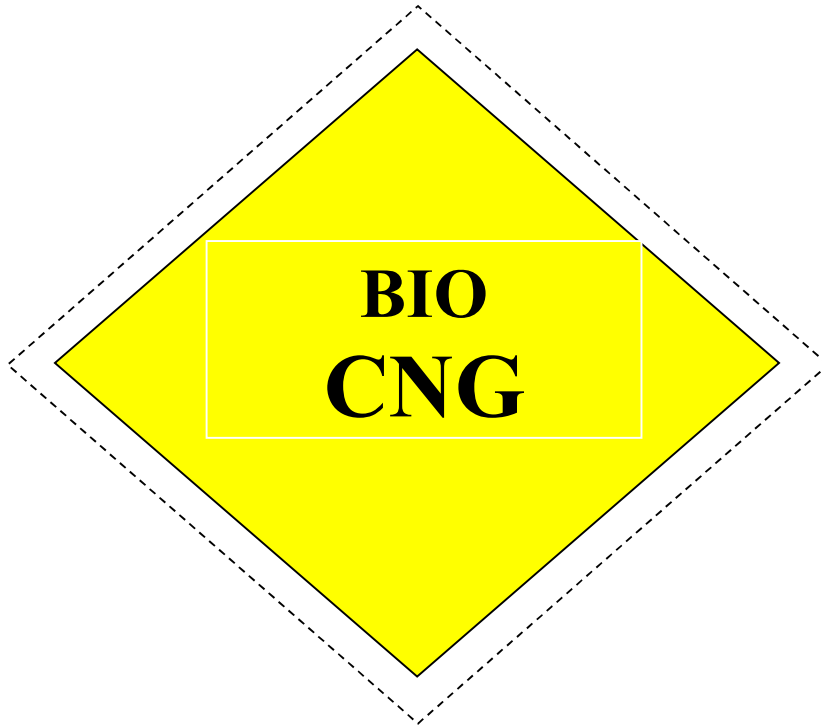

The sign consists of a sticker which shall be weather resistant.

The colour and dimensions of the sticker shall fulfil the following requirements:

A label shall be placed adjacent to the BIO CNG fill receptacle stating the fuelling requirements. The fuelling requirements shall be as recommended in this standard.

Colours:

Background:	Yellow
Letters:	Black or black reflecting

Dimensions:

Border width:	4 - 6 mm
Character height:	≥ 25 mm
Character thickness:	≥ 4 mm
Sticker width:	110 - 150 mm
Sticker height:	80 - 110 mm

The word "BIO CNG" shall be centred in the middle of the sticker.

APPENDIX C-4

Provisions on LNG identification mark for LNG vehicles

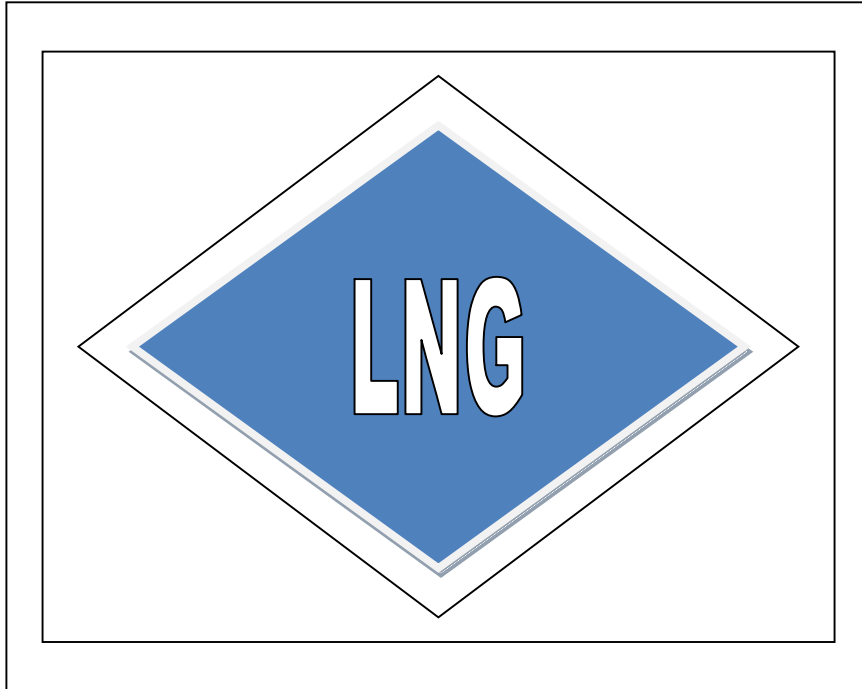

The sign consists of a sticker which shall be weather resistant.

The colour and dimensions of the sticker shall fulfil the following requirements:

A label shall be placed adjacent to the LNG fill receptacle stating the fuelling requirements. The fuelling requirements shall be as recommended in this standard.

Colours:

Background:	Blue
Letters:	White or white reflecting

Dimensions:

Border width:	4 - 6 mm
Character height:	≥ 25 mm
Character thickness:	≥ 4 mm
Sticker width:	110 - 150 mm
Sticker height:	80 - 110 mm

The word "LNG" shall be centred in the middle of the sticker.

APPENDIX D1

FILLING CONNECTION AND DUST PLUG

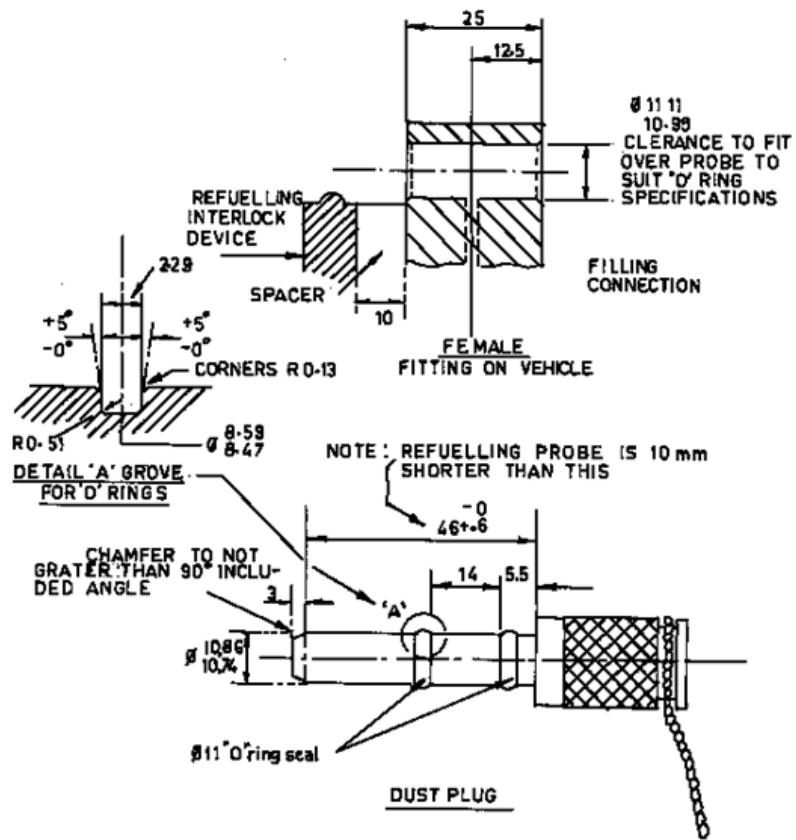

DUST PLUG CNG VEHICLE FILLING SYSTEM

APPENDIX E

FREEZING CONDITIONS AND CORROSIVE CONDITIONS

- E1 Where Regulator heat is drawn from the engine cooling water, care should be taken to ensure that the water PESOs not freeze in the Regulator during cold weather. Expansion of the water on freezing can cause serious damage to the pressure regulator assembly.
- E2 Most CNG / BIO-CNG Regulators are made from non-ferrous alloys, which can suffer pinhole corrosion under certain conditions. If this is allowed to take place CNG / BIO-CNG can be admitted to the cooling water system where it will pressurize the radiator and cause a potential hazard. It is important, therefore, to have an effective anticorrosion additive present in the cooling water.
- E3 It is important to ensure that the coolant additive and the dilutant ratio comply fully with the engine manufacturer's requirements.

APPENDIX F

TABLE FOR USE WITH CLAUSE 2.3.3.2 AND FIG. 1. ZONES OF CLEARANCE

Wheel base mm	Clearance height at 17° ramp angle (point A of Fig. 1) mm
1800	134
1900	142
2000	149
2100	157
2200	164
2300	172
2400	179
2500	187
2600	194
2700	202
2800	209
2900	216
3000	224
3100	231
3200	239
3300	246
3400	254
3500	261
3600	270
3700	276
3800	284
3900	291
4000	298
4100	306
4200	313
4300	321
4400	328
4500	336
4600	343
4700	351
4800	358
4900	366
5000	373

Note – If wheel base measurement falls between any of the figures shown above then the next highest figure is to apply.

APPENDIX G

BACKFIRE – DEFLECTOR TESTS

- 1) A backfire deflector under backfire conditions shall contain a visible flame front within its confines and shall not be displaced, physically damaged or distorted, or show evidence of burning or smoldering of internal parts. If the deflector is of the oil-bath type, it shall be free of any overflow or discharge permitting accumulation of oil on electrical, hot-engine or exhaust system parts.
- 2) A complete industrial truck / vehicle is to be used for this test. Tests are not required on backfire deflectors employed diesel engines.
- 3) The backfire deflector (air cleaner, oil-bath or dry element type) and connecting hose are to be removed from the engine. The spark timing is to be advanced (approximately 8 degrees) and the spark plug leads are to be interchanged to obtain sharp backfires under the following conditions. The engine is to be alternately raced and idled and the ignition switch is to be operated to alternately energize and de-energize the ignition system. During the test, the intensity of the backfire and the issuance and extent of the accompanying flame are to be noted.
- 4) The backfire deflector (air cleaner) is then to be installed on the truck in the intended location. An oil-bath type deflector (air cleaner) is to be filled to the marked “full level-line” of the bowl. Paper is to be placed beneath the intake orifices of an oil-bath type and over adjacent surfaces of parts likely to be affected by accumulations of oil.
- 5) The engine is then to be operated in the several manners determined in the preliminary test to provide for the most severe backfire conditions. At least ten and not more than twenty backfires are to be produced.
- 6) Observations for containment of flame are to be made under semi-darkened conditions by at least two observers. No visible flame is to be in evidence at any time during the tests. In the tests of an oil-bath type, paper is not to show evidence of oil deposits in the form of droplets.
- 7) A dry-type filter element is to be tested in the above manner, then removed and then subjected to five consecutive washing and drying cycles. Washing is to consist of immersion in plain water together with sufficient agitation to remove bulk material adhering to the outside surface. The test element is then to be remounted as intended in operation, and the backfire test is to be repeated.
- 8) The side of the filter media normally exposed to backfire is then to be subjected to a flame source of sufficient intensity to cause the media to burn or glow. The flame source is then to be removed and an acceptable filter media is not to continue to burn or smolder.

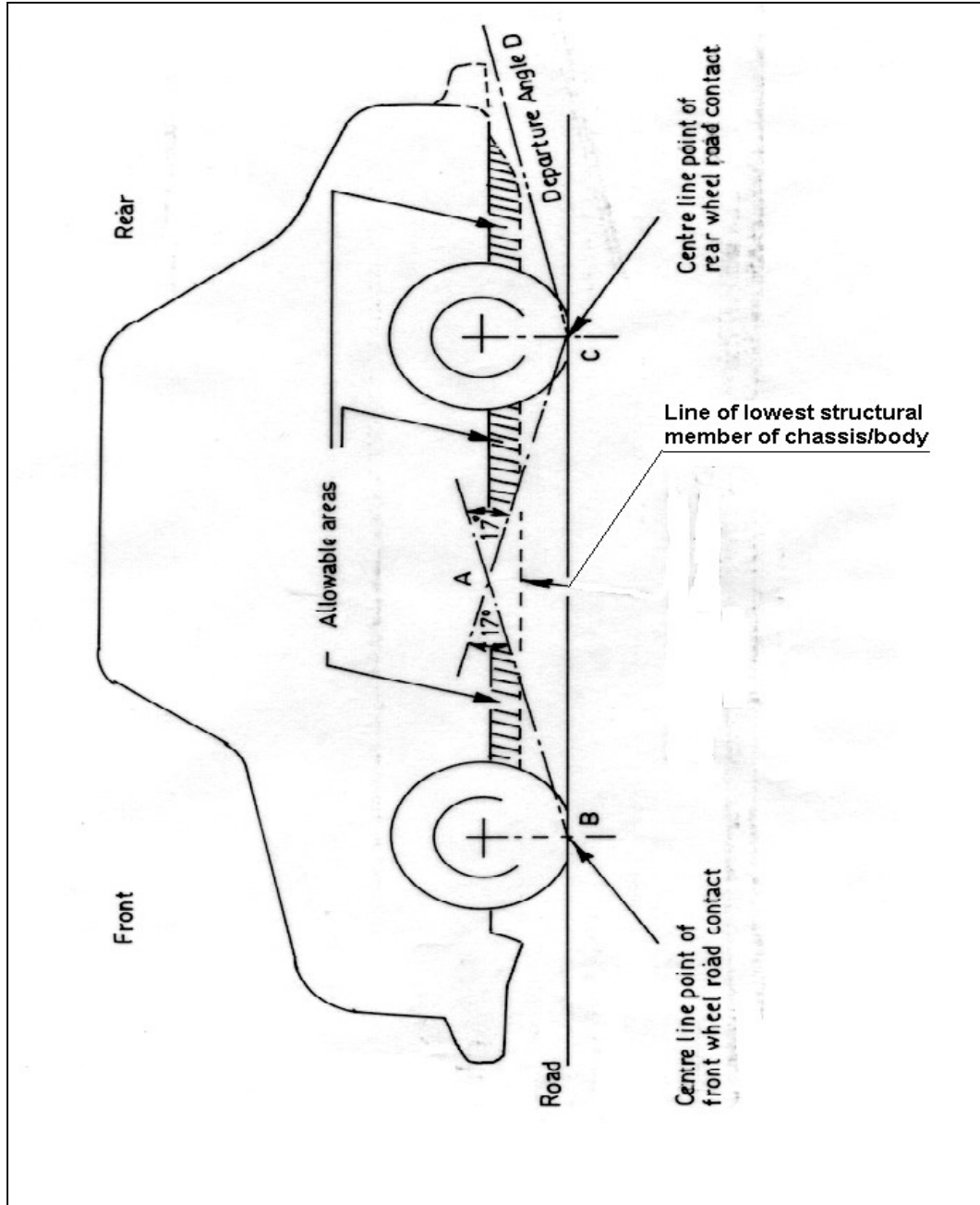

Figure 1

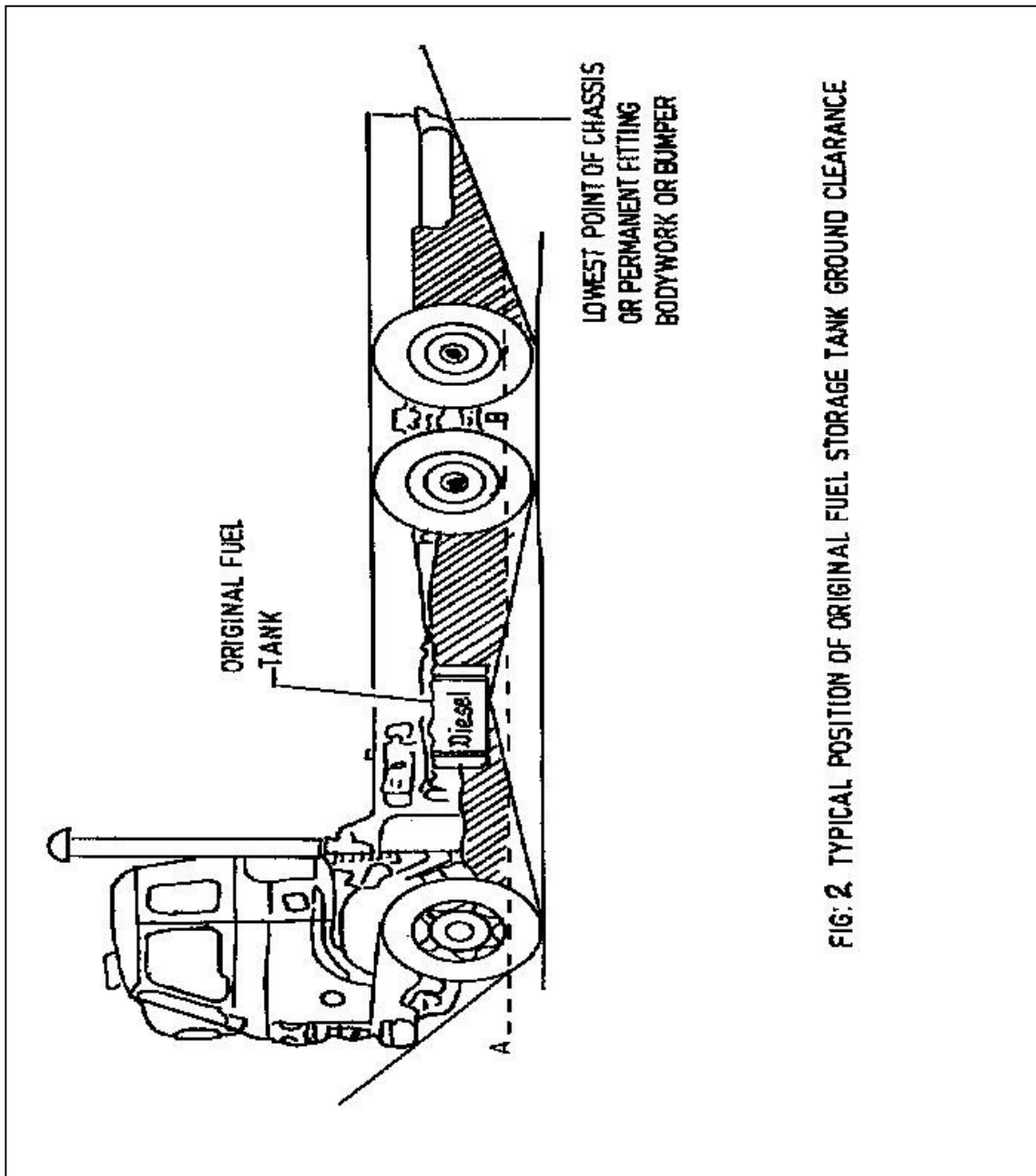

FIG: 2. TYPICAL POSITION OF ORIGINAL FUEL STORAGE TANK GROUND CLEARANCE

Figure 2

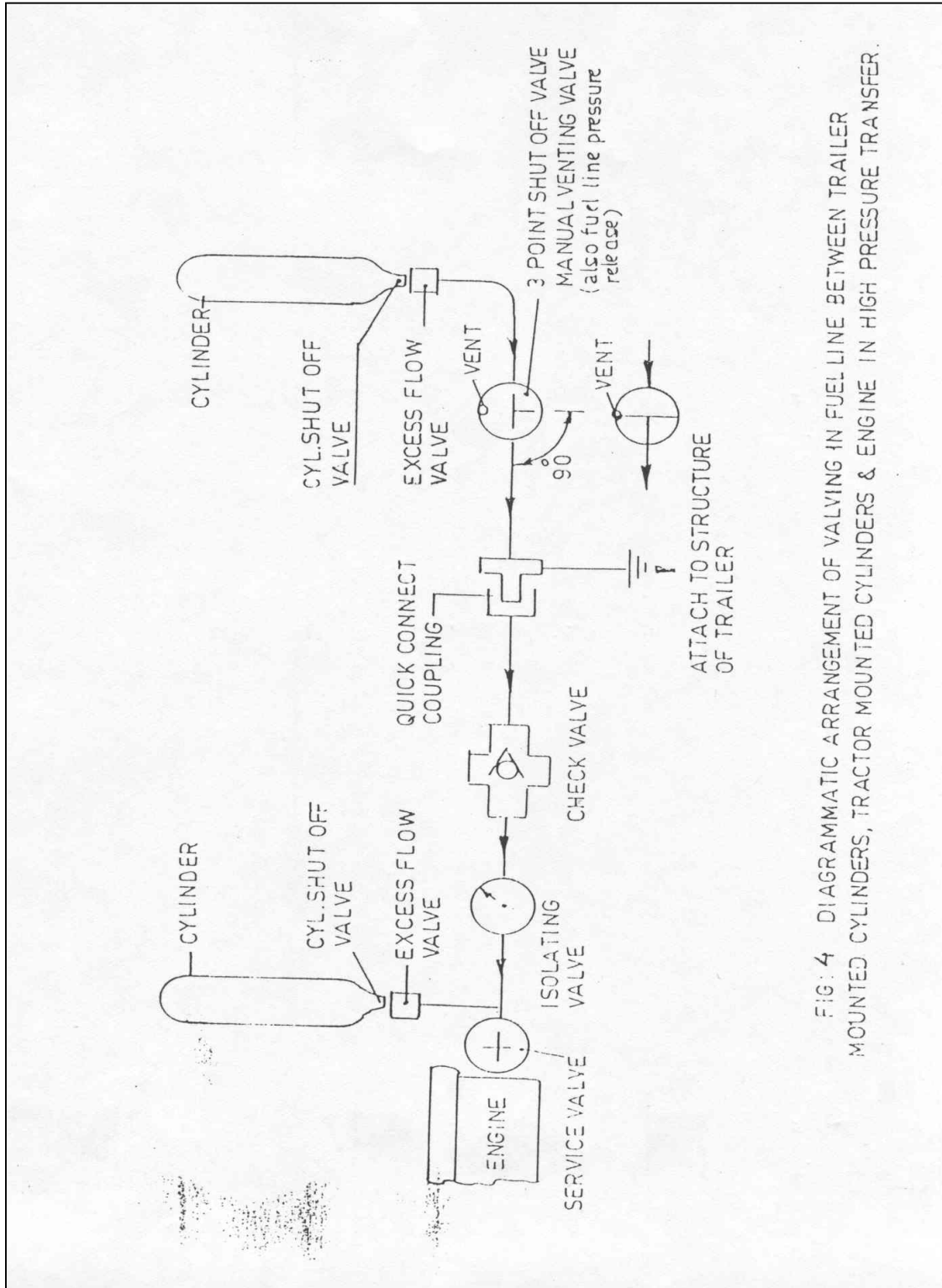
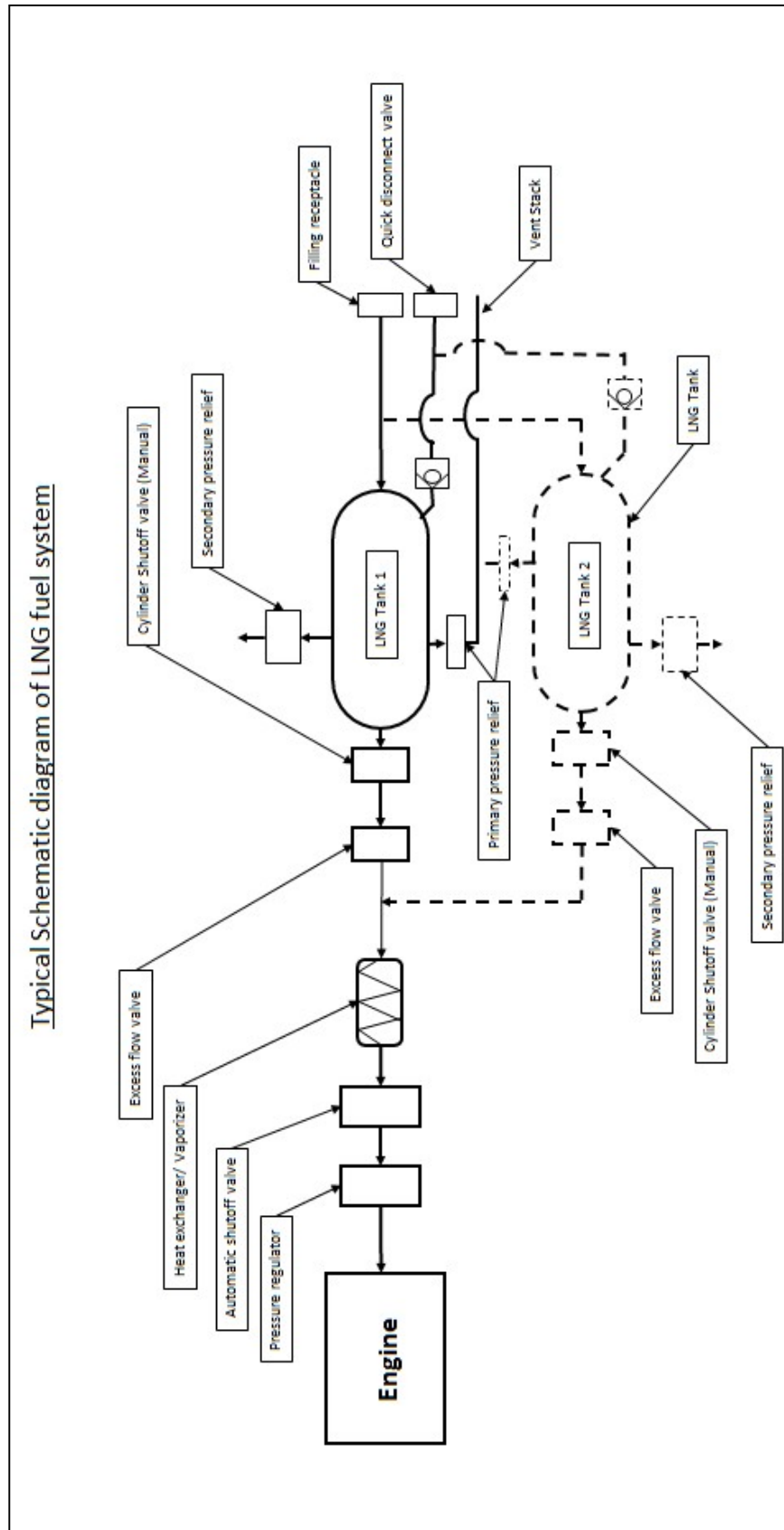

FIG: 4 DIAGRAMMATIC ARRANGEMENT OF VALVING IN FUEL LINE BETWEEN TRAILER MOUNTED CYLINDERS, TRACTOR MOUNTED CYLINDERS & ENGINE IN HIGH PRESSURE TRANSFER.

Figure 3

Typical Schematic diagram of LNG fuel system



ANNEX-XI
(See Introduction)

**COMPOSITION OF AISC PANEL ON SAFETY AND PROCEDURAL
REQUIREMENTS FOR TYPE APPROVAL OF CNG / BIO-CNG /Dedicated
OE LNG above 3.5T OPERATED VEHICLES
(Dedicated, Bi-Fuel and Dual Fuel)***

Convener	Organization
Dr. S. S. Thipse	Automotive Research Association of India (ARAI)
Members	Representing
Shri S.D. Rairikar	Automotive Research Association of India (ARAI)
Shri K. P. Kavathekar	Automotive Research Association of India (ARAI)
Shri Ajay Dekate	Automotive Research Association of India (ARAI)
Shri Kamalesh Patil	Automotive Research Association of India (ARAI)
Ms. Vijayanta Ahuja	International Centre for Automotive Technology (ICAT)
Shri Mahendra Pal	International Centre for Automotive Technology (ICAT)
Shri Mayank Sharma	International Centre for Automotive Technology (ICAT)
Shri Ashish Mallarh	International Centre for Automotive Technology (ICAT)
Shri S. N. Dhole	Central Institute of Road Transport (CIRT)
Shri Mahesh Pathak	Central Institute of Road Transport (CIRT)
Shri Diwit Prajapati	SIAM
Shri P. Gowrishankar	Tata Motors Ltd. (SIAM)
Shri Shailendra Devangan	Tata Motors Ltd. (SIAM)
Shri Alok Jaitley	Maruti Suzuki India Ltd.(SIAM)
Shri Gururaj Ravi	Maruti Suzuki India Ltd.(SIAM)
Shri Rajamani Parthiban	Mahindra and Mahindra (SIAM)
Shri Agam Kumar	Scania Ltd (SIAM)
Shri Vivek Rawat	JCB India Ltd.
Shri Shishir Agarwal	CLH Fuel Systems
Shri P. P. Kulkarni	Eco Fuel System

ANNEX-XII
(See Introduction)
COMMITTEE COMPOSITION *
Automotive Industry Standards Committee

Chairperson	
Shri Neelkanth V. Marathe	Officiating Director The Automotive Research Association of India, Pune
Members	Representing
Representative from	Ministry of Road Transport and Highways (Dept. of Road Transport and Highways), New Delhi
Representative from	Ministry of Heavy Industries and Public Enterprises (Department of Heavy Industry), New Delhi
Shri S. M. Ahuja	Office of the Development Commissioner, MSME, Ministry of Micro, Small and Medium Enterprises, New Delhi
Shri Shrikant R. Marathe	Former Chairman, AISC
Shri R.R. Singh	Bureau of Indian Standards, New Delhi
Director	Central Institute of Road Transport, Pune
Director	Global Automotive Research Centre
Director	International Centre for Automotive Technology, Manesar
Director	Indian Institute of Petroleum, Dehra Dun
Director	Vehicles Research and Development Establishment, Ahmednagar
Director	Indian Rubber Manufacturers Research Association
Representatives from	Society of Indian Automobile Manufacturers
Shri R. P. Vasudevan	Tractor Manufacturers Association, New Delhi
Shri Uday Harite	Automotive Components Manufacturers Association of India, New Delhi
Shri K. V. Krishnamurthy	Indian Construction Equipment Manufacturers Association

Member Secretary
Shri Vikram Tandon
Dy. General Manager
The Automotive Research Association of India, Pune

* At the time of approval of this Automotive Industry Standard (AIS)